

AL-6XN[®] Alloy

(UNS N08367)

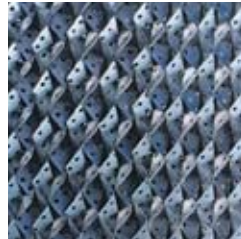



AL-6XN[®] Alloy

(UNS N08367)

Allegheny Ludlum AL-6XN[®] alloy (UNS N08367) is the most corrosion resistant iron-base austenitic stainless alloy produced by Allegheny Technologies at this time. It is a low carbon, high purity, nitrogen-bearing "super-austenitic" stainless alloy. The AL-6XN alloy was designed to be a seawater resistant material and has since been demonstrated to be resistant to a broad range of very corrosive environments. It is readily available from stock in a wide range of product forms, including thick plate that is suitable for multi-pass welding during field fabrication. The high strength and corrosion resistance of the AL-6XN alloy make it a better choice than the conventional duplex stainless steels and a cost effective alternative to more expensive nickel-base alloys in applications where excellent formability, weldability, strength and corrosion resistance are essential. It is also a cost-effective alternative to less expensive alloys, such as Type 316, that do not have the strength or corrosion resistance required to minimize life cycle costs in certain applications.

The high nickel and molybdenum contents provide improved resistance to chloride stress-corrosion cracking. Copper (Cu) has been intentionally kept to a residual level for improved performance in seawater⁴⁰. The high alloy composition of the AL-6XN alloy resists crevice corrosion and pitting in oxidizing chloride solutions to a degree previously achieved only by nickel-base alloys and titanium.

AL-6XN alloy is well suited for such applications as:

- Chemical process tanks and pipelines
- Process systems for offshore oil and gas platforms
- Condensers, heat exchangers and piping containing seawater or crude oil
- Filter washers, vats and press rolls in pulp bleaching plants
- Power plant flue gas scrubber environments
- Tall oil distillation columns and packing
- Desalination equipment and pumps
- Service water piping systems for nuclear power plants
- Transformer cases exposed to marine environments
- Pharmaceutical equipment (*for product purity*)
- Food processing equipment

CONTENTS

Introduction and Overview	1
Specifications	8
Applications	10
Corrosion Properties	14
Physical Properties	26
Mechanical Properties	28
Heat Treatment	32
Forming	34
Welding	38
Corrosion of Welds	43
Descaling, Pickling and Cleaning	46
References	49
Appendices	
Corrosion Testing AL-6XN [®] Alloy	51
Detention and Removal of	
Iron in Surface	53
Metallography	53
Disclaimers	54
Index	55

Chemical Composition

AL-6XN alloy offers the following distinct advantages:

- [Corrosion Resistance](#)

The intrinsic corrosion resistance of the AL-6XN alloy in both acidic and alkaline environments provides protection against metallic contamination of process streams and prevents rapid degradation of components made of the alloy.

- [Cost Effectiveness](#)

The AL-6XN alloy is often a viable alternative to non-metallic materials that can provide high levels of corrosion resistance but are costly to install and maintain. AL-6XN alloy is significantly less costly than most nickel-base alloys.

- [Workability](#)

The toughness and ductility of the AL-6XN alloy provide for relative ease of fabrication in the shop or in the field. The formability and weldability of the AL-6XN alloy are much better than that of high alloy ferritic or duplex stainless steels that demonstrate comparable resistance to corrosion.

- [As-Welded Properties](#)

The low carbon and high nitrogen contents in AL-6XN alloy minimize the precipitation of carbides and secondary phases that can occur during welding. Therefore as-welded assemblies can be placed in service, provided that a suitable over-matched filler metal is used and the assembly has been properly cleaned. AL-6XN alloy can be welded in the field using procedures similar to those used with other austenitic stainless steels.

- [Wide Range of Product Forms](#)

AL-6XN alloy is readily available in a wide range of product forms, such as tube, pipe, sheet, plate, bar, billet and forgings. Components such as pumps, valves, fittings, fasteners and castings are also available.

The typical and specified chemical compositions of AL-6XN alloy are presented in Table 1. The chromium, nickel and molybdenum contents are significantly higher in the AL-6XN alloy than in the standard Type 304L, 316L and 317L grades. The alloy has the designation UNS N08367 and is included in appropriate standards in the American Society for Testing and Materials (ASTM) annual book of standards. ASTM initially classified AL-6XN alloy with the nonferrous alloys in the "B" specification because the alloy contains slightly less than 50% iron. The alloy is listed with an "N" in the Unified Number System (UNS) for the same reason. For compatibility with international standards, ASTM has changed its definitions for steels and nickel alloys. Under these new definitions, AL-6XN alloy is now classified as a steel and is listed in ASTM specification A-240 and other "A" specifications. AL-6XN alloy will, however, remain in the "B" specifications for the foreseeable future.

The low carbon content of AL-6XN alloy distinguishes it as an "L" grade, providing high resistance to intergranular corrosion in the as-welded condition.

As demands placed upon AL-6XN alloy have become more severe, users have demanded that a higher alloy version of AL-6XN alloy be produced. Long experience in its production and diligent study of its metallurgy has allowed Allegheny Ludlum to produce an enhanced version of the standard AL-6XN[®] alloy. This enhanced version is called AL-6XN PLUS[™] alloy. Both versions satisfy the composition requirements of UNS N08367, but the AL-6XN PLUS alloy contains a greater concentration of the alloying elements (Cr, Mo, and N) which promote corrosion resistance. This is reflected in the Pitting Resistance Equivalent ($PREN = 1.0 \times \%Cr + 3.3 \times \%Mo + 30 \times \%N$), as shown in Table 1.

AL-6XN PLUS alloy is custom - melted on an as ordered basis, and is not available from stock.



Improved Corrosion Resistance and Strength

The goal of the Allegheny Ludlum metallurgists who developed the AL-6XN alloy was to create an austenitic stainless alloy that could be made in all product forms and would be immune to corrosion in stagnant seawater at ambient temperature. When the AL-6XN alloy is tested in a ferric chloride solution (ASTM G-48B), no signs of crevice attack are observed until the solution temperature is increased to 110°F (43°C) or greater - referred to as the Critical Crevice Corrosion Temperature (CCCT), as shown in Table 2. This exemplifies excellent resistance to crevice corrosion.

The wall thickness of a vessel can sometimes be significantly reduced with the use of a higher strength material, such as AL-6XN alloy. A comparison of the ASME data given in Table 3, shows the AL-6XN alloy to exhibit a minimum tensile strength and allowable stresses that are significantly greater than those for Type 316L and other stainless steels or copper-nickel alloys.

This high strength of the AL-6XN alloy is due in part to the interstitial strengthening effect of nitrogen. The combined features of increased strength with improved corrosion resistance have led to extensive usage of AL-6XN alloy in chemical plants and power plants.

DISCLAIMER: Values shown are for comparison only. Always consult current editions of codes and standards for values for use in design.

Referenced data are typical and should not be construed as maximum or minimum values for specification or for final design. Data on any particular piece of material may vary from those shown above.

TABLE 1: Chemical Composition (weight %)

Chemical Element	Typical AL-6XN® Alloy	Typical AL-6XN Plus™ Alloy	UNS N08367
C	0.02	0.02	0.03 max.
Mn	0.40	0.30	2.00 max.
P	0.020	0.020	0.040 max.
S	0.001	<0.001	0.030 max.
Si	0.40	0.35	1.00 max.
Cr	20.5	21.8	20.00 / 22.00
Ni	24.0	25.3	23.50 / 25.50
Mo	6.2	6.7	6.00 / 7.00
N	0.22	0.24	0.18 / 0.25
Cu	0.2	0.2	0.75 max.
Fe	Balance	Balance	Balance
PRE _N	47.5	50.0 min.	45.2/52.6

TABLE 2: Critical crevice-corrosion temperatures in 10% FeCl₃ • 6H₂O

Alloy	°F	°C
Type 316	27	-3
Alloy 825	27	-3
Type 317	36	2
Alloy 904L	59	15
Alloy 2205	68	20
E-BRITE®	70	21
Alloy G	86	30
Alloy 625	100	38
AL-6XN®	110	43
AL 29-4C®	127	53
Alloy 276	130	55

Alloy Development

The 18Cr-8Ni austenitic stainless steels have been successfully used in fresh water and mildly corrosive industrial conditions for more than 50 years. The corrosion resistance, weldability and strength of the austenitic family of alloys have been constantly improved for more demanding industrial applications by changing the basic chemical composition.

- Molybdenum was added to enhance corrosion resistance in chloride environments.
- Carbon was reduced to avoid sensitization during welding.
- Nitrogen was added to compensate for the reduced strength of the "L" grades and to improve pitting resistance and phase stability.
- Chromium was increased to enhance pitting and crevice corrosion resistance.
- Nickel was increased to stabilize the austenitic microstructure and to improve resistance to general corrosion in reducing environments.

Condenser tubing of the basic 18Cr-8Ni stainless steel composition known as Type 304 was first used in the 1950s to replace copper-based alloys that had failed due to ammonia stress-corrosion cracking, erosion by steam impingement and pitting in acidic river water. Most of the initial applications were for Type 304 in fresh, industrial and acidic mine waters. More than 500 million feet (152 million meters) of Type 304 stainless steel tubing have been installed in condensers and most remain in service today. Type 316, which contains molybdenum and slightly higher nickel levels, was used in more corrosive situations. The alloy content of Type 316 was found to be too lean to prevent pitting and crevice corrosion in certain applications, such as those involving stagnant seawater. Neither Type 304 nor Type 316 suffered ammonia stress-corrosion cracking or steam impingement erosion as did the copper-based alloys.

Stainless alloys with even higher levels of chromium (Cr) and molybdenum (Mo) were developed to resist the high chloride ion concentrations of brackish water and seawater. One of the results of Allegheny Ludlum's earliest efforts to develop better austenitic stainless alloys, was the introduction of AL-6X™ alloy in the early 1970s. The alloy contained 20 wt % Cr, 24 wt % Ni and 6 wt % Mo. The relatively high nickel (Ni) content promotes a fully austenitic structure in the annealed condition. In 1973, AL-6X alloy became the first thin wall austenitic stainless tubing material to be successfully used in seawater-cooled utility condens-

TABLE 3: Tensile strengths and ASME design limits for flat rolled and tubular products less than 3/16" (0.48 cm) thick. (Dimensionally stable)

Alloy	Min. Tensile Strength, psi (MPa) at room temp.		Max. Stress psi (MPa) at 200°F		Max. Temp. of use °F (°C)	
90 / 10 Cu-Ni	40,000	(275)	9,500	(65.5)	600	(315)
Type 316L	70,000	(483)	14,200	(97.9)	850	(454)
Alloy 904L	71,000	(490)	16,700	(115.1)	700	(371)
Alloy 28	73,000	(503)	18,900	(130.3)	600	(315)
Alloy 20	80,000	(552)	20,600	(142.0)	1000	(538)
Alloy 2205	90,000	(620)	25,700	(177.2)	600	(315)
Alloy G	90,000	(620)	21,000	(144.8)	1000	(538)
254SMO*	94,000	(648)	23,900	(164.8)	750	(399)
Nitronic 50**	100,000	(690)	28,400	(195.8)	1200	(649)
Alloy 276	100,000	(690)	24,900	(171.6)	1250	(677)
AL-6XN®	100,000	(690)	26,200	(180.6)	800	(427)

* Trademark of Avesta Sheffield

** Trademark of AK Steel



ers. The original installations are still performing well after almost 30 years of service. More than 30 million feet (10 million meters) of AL-6X alloy tubing have gone into these applications, most of which involve chloride-laden cooling waters.

One significant problem with the AL-6X alloy was that the product forms and sizes produced were quite limited for metallurgical reasons. The high chromium and molybdenum content of the alloy rendered AL-6X alloy susceptible to the formation of secondary (sigma) phases upon slow cooling through the 2100 to 1000°F (1150 to 540°C) temperature range. Sheet and strip products thicker than 0.1875 inches (4.75 mm) could not be cooled quickly enough to prevent the precipitation of secondary phases that are deleterious to corrosion resistance and toughness. Consequently, commercial AL-6X alloy products were limited to thicknesses less than 0.10 inches (2.5 mm).

Nitrogen was found to be effective in retarding the formation and altering the morphology and distribution of secondary phases. Nitrogen also enhances the effects of chromium and molybdenum by improving resistance to pitting, crevice corrosion and stress-corrosion cracking.

The AL-6XN alloy was developed as an improvement over the AL-6X alloy. Both alloys have the same basic alloy composition except that the AL-6XN alloy contains an intentional addition of 0.18 to 0.25% N. In new applications, AL-6XN alloy is used instead of

AL-6X alloy. Over 30 million feet (10 million meters) of thin-wall AL-6XN alloy condenser tubing are currently in service. These tubes have been operating for periods up to 18 years in brackish or sea waters, where resistance to even minor pitting is vitally important. In most of these condenser tube applications, the AL-6XN alloy replaced copper alloys and was selected in preference to titanium.

The conventional ferric chloride crevice corrosion test has been shown to be a sensitive indicator of the presence of sigma phase in high molybdenum stainless steels. The times at temperature needed to cause a 0.001 gram weight loss from heat-treated samples of AL-6X alloy and AL-6XN alloy exposed to 6% ferric chloride (10 wt% $\text{FeCl}_3 \cdot 6\text{H}_2\text{O}$) at 75°F (21°C) are indicated by the two curves in Figure 1¹. The shift in the C-curve for the AL-6XN alloy indicates that the time for precipitation of sigma was delayed by two orders of magnitude relative to the nitrogen-free AL-6X alloy. The range of aging temperatures resulting in equivalent weight loss was also reduced by over 360°F (200°C) for the AL-6XN alloy compared to the AL-6X alloy. In addition to defining the sigma precipitation range for these alloys, Figure 1 shows that the crevice corrosion resistance of AL-6XN alloy is maintained even after being exposed to a wide range of temperatures for long periods of time.

Metallurgical Stability

The AL-6XN alloy is metallurgically stable to 950°F (510°C). On long exposures to higher temperatures in the 1200-1800°F (650-980°C) range, sigma phase may precipitate in grain boundaries. Sigma phase can have an adverse effect on corrosion resistance, and this can be correlated with metallographic appearance of AL-6XN alloy³⁰. Sigma phase precipitation will impair the corrosion resistance of AL-6XN alloy long before it influences mechanical properties³¹.

Figure 2 shows the influence of nitrogen on the formation of sigma phase particles on grain boundaries of a 6% Mo alloy after a 10-minute exposure at 1472°F (800°C) followed by an air cool. The intergranular precipitates that form in the 6% Mo alloy containing only 0.050 wt % N are not present when the nitrogen content is raised to 0.18 wt %. This suppression of sigma precipitation with increasing alloy nitrogen content is also observed in thick plates as well as the heat-affected zones of plate welds. Traces of intermetallic (sigma) phases may be present near the centerline of the material. Such "centerline sigma phase" does not

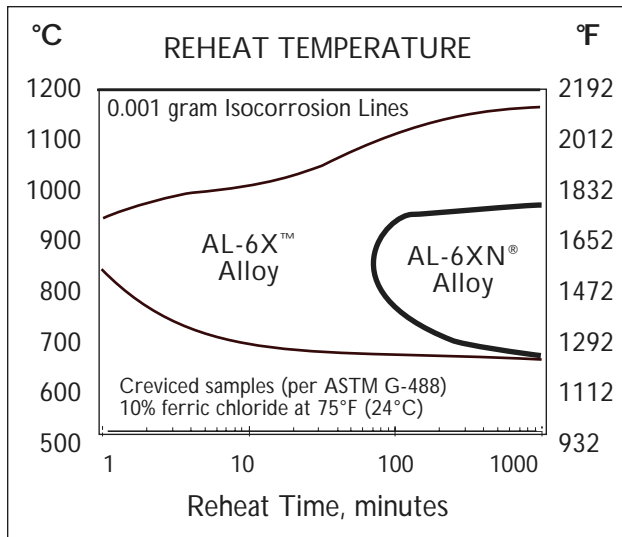

FIGURE 1: Time-temperature-corrosion curves for heat-treated samples (0.001 gram weight).

significantly influence the mechanical or corrosion properties of the alloy. The high nickel content of the AL-6XN alloy contributes to the inhibition of formation of sigma phase.

Product Forms

Allegheny Ludlum produces a full range of AL-6XN alloy flat-rolled products (plate, sheet & strip) AL-6XN long products (billet, bar, rod, coil, and wire) are produced by Allvac, an Allegheny Technologies Company. Other product forms are also available from experienced domestic and European manufactures, including: welded tube, pipe, forgings, castings, fittings and flanges.

Most mill products are available from inventory.

Cast Product

The cast form of AL-6XN alloy is designated CN-3MN (UNS J94651). CN-3MN castings are typically melted to slightly different compositions than are found in wrought AL-6XN alloy. Increased levels of silicon and manganese are necessary to increase the fluidity and castability of the alloy. Sulfur and phosphorus are restricted to minimize cracking as well as to facilitate the welding of cast parts into fabricated assemblies. All CN-3MN castings must be given a solution-annealing treatment followed by rapid cooling.

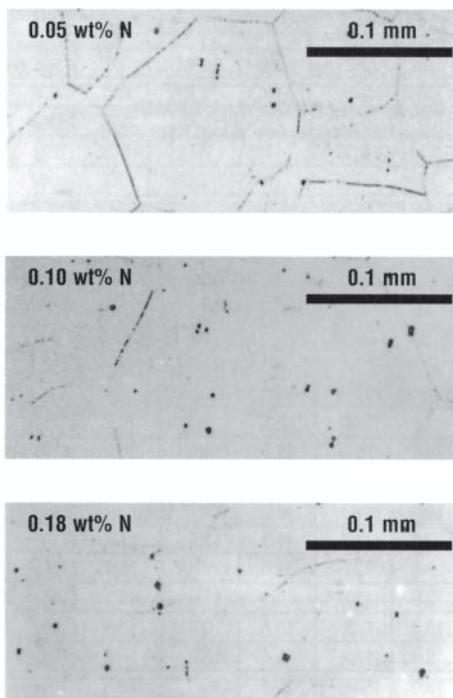
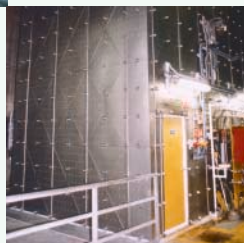

FIGURE 2: Effect of nitrogen on sigma phase precipitation.



Specifications

The American Society for Mechanical Engineers (ASME) and American Society for Testing and Materials (ASTM) specifications for the wide range of AL-6XN alloy (UNS N08367) product forms are listed in Table 4. Additional coverage by various domestic and international agencies is in the process of approval.

The ASME maximum allowable design stress values for many AL-6XN alloy product forms are listed in Tables 5 and 6. AL-6XN wrought product is listed in the ASME Boiler and Pressure Vessel Code as N08367 in Section II, Part D. AL-6XN cast product is listed as J94651, CN-3MN. AL-6XN alloy is approved for use to 800°F (427°C) for Section III (Nuclear) and Section VIII Division 1 (unfired pressure vessel) applications. AL-6N alloy has been assigned to External Pressure Chart NFN-12. Use of AL-6XN alloy is allowed in the ASME Code for Pressure Piping, Sections B31.1 – Power Piping – and B31.3 – Process Piping – as UNS N08367.

Note that the stress values presented in Table 6 are higher than those in Table 5. The values in Table 6 exceed 67.5% but do not exceed 90% of the yield strength for the alloy at the cited temperature. Using AL-6XN alloy at these stresses is permissible according to the ASME code, but may result in dimensional change. The higher values are not recommended for applications such as flanges or gasketed joints where slight distortions can cause leakage or malfunction.

Use of AL-6XN alloy in contact with hydrogen sulfide-containing petroleum and natural gas is approved by NACE MR0175 for both annealed and cold worked material with hardness of Rockwell C 35 or below. Norsok standard M-DP-001, Rev. 1 (December 1994) lists AL-6XN alloy as approved for use on Norwegian offshore oil platforms.

Use of AL-6XN alloy in contact with foods has been approved by the U. S. Food and Drug Administration (FDA) and the National Sanitation Foundation (NSF).

TABLE 4: ASTM & ASME specifications for AL-6XN® (UNS N08367) Alloy Products

Product	ASME	ASTM
Plate, Sheet and Strip	SA-240, SB-688	A 240, B 688
Bars and Shapes		A 479
Rod, Bar and Wire	SB-691	B 691
Bolting		A 194
Welded Pipe	SA-358, SA-409 SA-813, SA814	A 358, A409 A 813, A 814
Seamless and Welded Pipe	SA-312	A 312
Seamless and Welded Tube	-	A 269, A270
	SB-829	B 829
Welded Tube	SA-249, SA-688	A 249, A 688
	SB-676	B 676
Seamless Pipe and Tube	SB-690	B 690
Billets and Bars for Reforging	-	B 472
Pipe Flanges, Fittings and Valves	SB-462	A 182, B 462
Wrought Nickel Alloy		
Welded Fittings	SB-366	B 366
Nickel Alloy Forgings	SB-564	B 564
Pipe Welded with Filler	SB-804	B 804
Castings (CN-3MN, UNS J94651)	SA-351	A 351, A 743, A744
Powder Metal Product	-	B 834

CAUTION: Values shown are for comparison only. Always consult current editions of codes and standards for values for use in design.

TABLE 5: ASME maximum allowable design stresses for AL-6XN ® Alloy: dimensionally STABLE.

Maximum Allowable Design Stress Values in Tension, ksi (MPa) DIMENSIONALLY STABLE Under Cited Conditions								
For Metal Temperature Not Exceeding °F °C	<3/16 Inch Thick Sheet, Strip, Seamless		>3/16-3/4 Inch Thick Plate, Bar, Forgings		Welded Tube , Welded Pipe <3/16 Inch Wall		Welded Pipe >3/16 Inch Wall	
	45 YS	(310)	45 YS	(310)	45 YS	(310)	45 YS	(310)
	100 TS	(717)	95 TS	(655)	100 TS	(717)	95 TS	(655)
100 38	28.6	(197)	27.1	(187)	24.3	(167)	23.1	(159)
200 93	26.2	(181)	26.2	(181)	22.2	(153)	22.2	(153)
300 149	23.8	(164)	23.8	(164)	20.2	(139)	20.2	(139)
400 204	21.9	(151)	21.9	(151)	18.7	(129)	18.7	(129)
500 260	20.5	(141)	20.5	(141)	17.4	(120)	17.4	(120)
600 316	19.4	(134)	19.4	(134)	16.5	(114)	16.5	(114)
650 343	19.0	(131)	19.0	(131)	16.1	(111)	16.1	(111)
700 371	18.6	(128)	18.6	(128)	15.8	(109)	15.8	(109)
750 399	18.3	(126)	18.3	(126)	15.5	(107)	15.5	(107)
800 427	18.0	(124)	18.0	(124)	15.3	(105)	15.3	(105)

KEY: YS = Minimum Yield Strength 0.2% offset; TS = Minimum Tensile Strength;

All product forms have a minimum 30% elongation in 2" or 4D.

Values shown are for comparison only. Always consult current editions of codes and standards for values for use in design.

Values are as-published in 2001 Edition of Code. Always consult current editions of codes and standards for values for use in design.

TABLE 6: ASME maximum allowable design stresses for AL-6XN ® Alloy: dimensionally UNSTABLE.

Maximum Allowable Design Stress Values in Tension, ksi (MPa) DIMENSIONALLY UNSTABLE Under Cited Conditions								
For Metal Temperature Not Exceeding °F °C	<3/16 Inch Thick Sheet, Strip, Seamless		>3/16-3/4 Inch Thick Plate, Bar, Forgings		Welded Tube , Welded Pipe <3/16 Inch Wall		Welded Pipe >3/16 Inch Wall	
	45 YS	(310)	45 YS	(310)	45 YS	(310)	45 YS	(310)
	100 TS	(717)	95 TS	(655)	100 TS	(717)	95 TS	(655)
100 38	28.6	(197)	27.1	(187)	24.3	(167)	23.1	(159)
200 93	28.6	(197)	27.1	(187)	24.3	(167)	23.1	(159)
300 149	27.0	(186)	25.7	(177)	23.0	(158)	21.8	(150)
400 204	25.8	(178)	24.6	(170)	22.0	(152)	20.9	(144)
500 260	25.0	(172)	23.8	(164)	21.3	(147)	20.2	(139)
600 316	24.5	(169)	23.3	(161)	20.8	(143)	19.8	(136)
650 343	24.3	(167)	23.1	(159)	20.7	(143)	19.6	(135)
700 371	24.1	(166)	22.9	(158)	20.5	(141)	19.5	(134)
750 399	24.0	(165)	22.8	(157)	20.4	(141)	19.4	(134)
800 427	23.8	(164)	22.6	(156)	20.2	(139)	19.2	(132)

KEY: YS = Minimum Yield Strength 0.2% offset; TS = Minimum Tensile Strength;

All product forms have a minimum 30% elongation in 2" or 4D.

Values shown are for comparison only. Always consult current editions of codes and standards for values for use in design.

Values are as-published in 2001 Edition of Code. Always consult current editions of codes and standards for values for use in design.

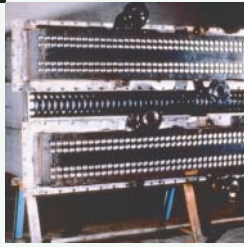

APPLICATIONS

Chemical Process

Pulp and Paper

Marine and Offshore

Air Pollution Control

Power

Other Applications

Biosphere

Food Processing

Residential Furnace

Applications

The applications of AL-6XN alloy described in this section are typical examples of the uses of this highly resistant alloy in very corrosive environments. It is not possible to include all the applications for the alloy, particularly since new ones are constantly being developed. The following examples are intended as a guide to show how the alloy is currently being used and to indicate how it might be used in the future.²⁻⁹

Chemical Process

The suitability of the AISI 300 and 400 series stainless steel for use in the chemical process industries (CPI) has significantly changed due to:

- Increased operating temperatures and pressures
- Corrosive minor process stream constituents, particularly in closed loops
- Severe restrictions on product impurities and effluent contents
- Demands for extended service life with minimum maintenance
- Increased cost of an unscheduled outage
- Competitive products from around the world.

More efficient and environmentally safe processes often require more expensive corrosion resistant materials. The AL-6XN alloy fills the gap between the corrosion performance of conventional Type 316 stainless steel and nickel-base Alloy 625 or Alloy 276. This allows the design of systems that optimize cost and performance.

The ideal applications for AL-6XN alloy are in environments where alloys such as Type 317 and Alloy 904L fail but the expense of high nickel alloys such as Alloy 276 is not justified. The AL-6XN alloy is superior to Alloy 904L, Alloy 20 and Alloy 825 in resistance to a broad range of corrosive environments. Strength, cost, corrosion resistance and availability of a wide range of product forms make the AL-6XN alloy a viable alternative to higher cost alloys such as alloys G, 625, 276 and titanium for many applications. Equipment that fails by pitting, crevice corrosion or

stress-corrosion cracking when fabricated from Type 316 or Type 317 is substantially upgraded when replaced by AL-6XN alloy.

Pulp and Paper

The acid stages of pulp and paper bleaching plants present some of the most severe industrial conditions for the pitting and crevice corrosion of stainless steels. Chlorine and chlorine dioxide bleaching chemicals create strongly oxidizing solutions that are very aggressive toward stainless steel.¹⁰⁻¹² Seawater or contaminated fresh water is used in various process stages of many plants and in closed process cycles. Tests that have been conducted in bleaching plants^{1,13} have demonstrated that corrosion attack is less temperature dependent for molybdenum-bearing stainless steels. Numerous cases have demonstrated that the performance of a molybdenum-bearing austenitic stainless steel is further improved by alloying with nitrogen.^{3,10} AL-6XN alloy exhibited no pitting or crevice corrosion when exposed for one year to a "moderately severe chlorination-stage environment" in a pulp mill bleach plant.⁴³

The austenitic stainless alloys in most pulp bleaching plants have had molybdenum contents between 2.0 and 3.5 wt % (e.g., Type 316L and Type 317L), and in some cases as high as 4.5 wt % molybdenum (Alloy 904L and Type 317LX). The high alloy content of the AL-6XN alloy provides improved resistance to thio-sulfate ($S_2O_3^{2-}$), pitting corrosion and stress-corrosion cracking (SCC) caused by chlorides, sulfur compounds, or caustic solutions. These compounds are present in white-water and Kraft black liquor environments and have caused corrosion of sensitized weld heat-affected zones in Type 304 and, in certain cases, Type 316. Intergranular SCC caused by sulfur compounds can also occur during the acid cleaning of sensitized stainless steels in Kraft liquor systems.

Process changes, such as recycling of wash water and higher operating temperatures, have resulted in serious corrosion problems in piping at many of the pulp bleaching plants currently using Type 317L pipe. With higher (6 wt. %) molybdenum content, the AL-6XN alloy has proven to be a significant upgrade material for Type 317L replacement.

Marine and Offshore

AL-6XN alloy offers resistance to many hostile off-

shore environments such as are found in seawater piping systems (e.g., fire protection), process piping systems, heat exchanger equipment, splash zones and support structures. Practical experience combined with numbers of field trials have shown that AL-6XN alloy has excellent resistance to crevice corrosion in seawater, even at high temperatures, under prolonged periods of stagnation, or with chlorination⁴⁴. AL-6XN alloy has found wide application in offshore drilling platforms and is also ideally suited for desalination systems. For example, approximately 475 tons (430 tonnes) of AL-6XN alloy was used by Statoil (Norway) on the Gullfaks platform. Over 600 tons (545 tonnes) of AL-6XN alloy were used on Conoco's Heidrun platform, also in Norway.

Air Pollution Control

Laboratory tests, field trials and practical experience show that AL-6XN alloy displays good resistance to attack in the acidic, oxidizing, halide solutions that often occur in flue gas cleaning⁴⁷. AL-6XN alloy is superior to conventional stainless steels and some nickel-based alloys that contact the acid condensates and washing solutions that are encountered in the cleaning of flue and other waste gasses. In many cases the corrosion resistance of AL-6XN alloy is equivalent to that of the more highly alloyed nickel-base alloys. Life cycle cost analysis has shown AL-6XN alloy to be an effective alternative to type 317 stainless steel or alloy 276 in absorber vessels and spray systems. The upper photo on the facing page illustrates the installation of AL-6XN duct lining in the flue gas treatment section of Petersburg No.2 station of Indianapolis Power & Light.

The flue-gas reheater pictured on the facing page left utilizes AL-6XN alloy tubesheets and U-bent tubing. The function of this unit is to increase the buoyancy of scrubbed flue gas so it will rise all the way up the stack as well as minimize corrosion by the condensation of flue gases cooled below the dewpoint. AL-6XN alloy was chosen for this application to resist chloride pitting and chloride stress-corrosion cracking on the steam side, acid corrosion from the cool, moist, sulfur-containing flue gas and erosion by steam impingement.

Power

Tremendous quantities of raw and treated water are required in the production of electricity. Water that is recirculated becomes quite corrosive due to the con-



Power plants have resorted to controlling MIC by selecting materials that are highly resistant to localized attack for four principal reasons:

1. Conventional water piping systems are not designed to facilitate routine cleaning, water treatment and monitoring.
2. Restrictions on environmental pollution limit the effectiveness of water treatment programs in controlling MIC and biofouling.
3. Water treatment and electrochemical protection programs can greatly accelerate the corrosion of certain metals. For example, AL-6XN alloy is resistant to the chlorination treatments that cause rapid corrosion of copper-base alloys.
4. Cement-lined carbon steel pipe typically has exposed bare metal at weld joints. The cement lining is susceptible to cracking which can cause early failures, while permeation of chloride ions through an intact coating will eventually cause the steel to corrode under the coating, leading to spalling and corrosion.

A variety of materials including cement-lined carbon steel pipe, Types 304 and 316 stainless, and Cu-Ni alloys have suffered MIC in nuclear power plant service water systems. The AL-6XN alloy has been chosen as a replacement for these other materials based on the results of test programs conducted by several utilities³⁶⁻³⁹ and its availability in many product forms. Several utilities regard the corrosion resistance of AL-6XN alloy important to controlling MIC problems during the 30 to 40 year expected operating life.

Other Applications

Although AL-6XN alloy was originally developed for power plant condensers cooled with seawater, the combination of excellent corrosion resistance, weldability, formability, and strength has been exploited in a wide variety of products and industrial systems. A few of these applications are described below.

Space Biosphere — Biosphere II is a prototype space station which was built in the Arizona desert. It is a self-contained environment in which eight people lived for two years (1991-1993), and which another crew inhabited 1993-1994. The biosphere consists of 5 million cubic feet of enclosed space, including an artificial ocean with fish, on a base of more than 60,000 square

centration of entrapped gases, minerals and impurities. The chlorides and sulfides in brackish and polluted water sources can cause rapid failure of AISI 300 series stainless steels by localized attack. Steam impingement can accelerate metal loss through cavitation and erosion corrosion. The superior resistance of the AL-6XN alloy to chlorides, stress-corrosion cracking and erosion make it an excellent choice for condenser tubing, service water piping, deaerator heaters, moisture separator reheaters, feedwater heaters and flue-gas reheaters.

Microbially influenced corrosion (MIC) and biofouling of service water piping and condensers can be so severe it can affect the operation of a plant. Systems that remain stagnant because of their standby or redundant nature are particularly susceptible. Such systems include:

- Service water piping
- Storage tank
- Fire protection
- Emergency heat extraction

feet of AL-6XN sheet. Biosphere II was designed to have a 100 year lifespan. AL-6XN alloy was chosen for its weldability, resistance to corrosion by seawater and reasonably low coefficient of thermal expansion.

Food Processing — Salt (sodium chloride) is a basic ingredient of food recipes and is present in almost all food process environments. Other aggressive chlorides, such as sodium hypochlorite, are found in the solutions used to clean process units while in place. The AL-6XN alloy is used to resist hot and cold environments - from the steam used during the final stages of food production to the brines used in cooling and chilling circuits. The AL-6XN alloy has been successfully used to replace Type 304 and Type 316 that have failed due to pitting, crevice corrosion and stress-corrosion cracking in many food process systems including brewery piping, meat cookers, cereal cookers, baby food tanks and corn syrup refineries. According to the United States Food and Drug Administration, the AL-6XN alloy is highly resistant as a food contact material and is not subject to food additive regulations (copy available upon request).

High Efficiency Residential Furnaces – Fuel efficient home heating furnaces incorporate secondary heat exchangers that condense flue gases before exhausting them. Crucial to the development of high efficiency residential furnaces is the availability of metals that resist the acids (carbonic, nitric, sulfuric, hydrochloric and hydrofluoric acids) and halogen ions (fluorides and chlorides) that condense on heat exchanger surfaces. The AL-6XN alloy has been used for some of these applications because its resistance to pitting, general corrosion and stress-corrosion cracking is matched by excellent cold-formability.

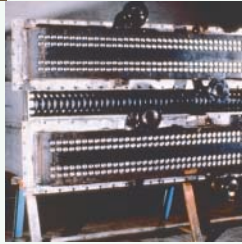
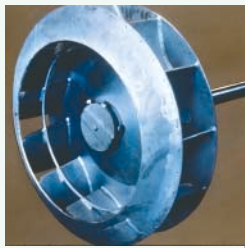

CORROSION PROPERTIES

Pitting

Crevice Corrosion

Critical Crevice Corrosion Temperature (CCCT)

Natural Seawater

Dissimilar Metal Crevices (DMC)

Effects of pH

Galvanic Compatibility

Intergranular Corrosion (IGC)

General Corrosion

Caustic and Alkaline-Salt Solutions

Stress-Corrosion Cracking (SCC)

Microbially Influenced Corrosion (MIC)

Erosion Corrosion

Corrosion Properties

Important design decisions are often based on corrosion data obtained from accelerated laboratory and field tests. Predicting actual performance in service from such tests requires an understanding of both the metallurgical and the environmental factors that may affect an alloy. The factors that induce corrosion in a real process must be identified and then controlled in an accelerated test for it to be a reliable indicator of actual performance.

The most frequent mode of failure for stainless alloys is localized corrosion induced by chlorides; specifically, pitting, crevice corrosion and stress-corrosion cracking. Austenitic stainless alloys can also corrode by general or intergranular modes of attack in acids and alkalis that do not contain chlorides or other halides. Data from several laboratory and field tests are presented to cover a wide range of possible process solutions.

Pitting

One of the most important characteristics of a stainless alloy exposed to solutions containing chlorides, such as seawater or flue-gas condensate, is resistance to pitting and crevice attack. The pitting resistance of an austenitic stainless alloy can be correlated to alloy composition in terms of the Pitting Resistance Equivalent (PREN) = % Cr + 3.3% Mo + 30% N; where chromium, molybdenum and nitrogen are in wt %. The PREN values for several alloys are given in Table 7 along with other common pitting and crevice corrosion indices. The relative rankings according to all indices are consistent and demonstrate the superior pitting and crevice corrosion resistance of the AL-6XN alloy.

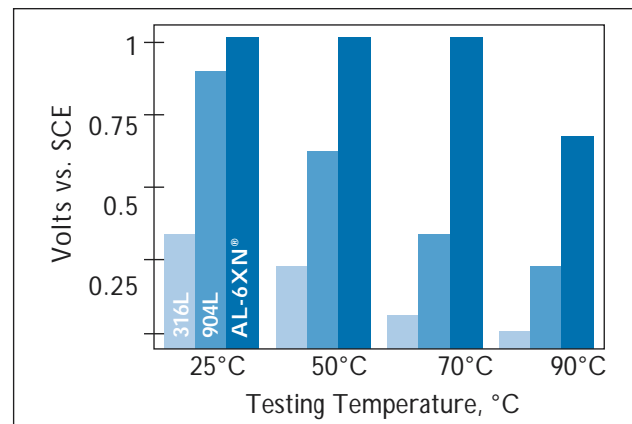

FIGURE 3: Pitting potentials in 3.5% NaCl solutions.

TABLE 7: Pitting and crevice corrosion indices.

Alloy	Composition (Wt. %)			PRE _N ¹	CCCT ²		ECPT ³		CPT ⁴	
	Cr	Mo	N		°F	(°C)	°F	(°C)	°F	(°C)
Type 304	18.0	–	0.06	19.8	<27.5	(<2.5)	–	–	–	–
Type 316	16.5	2.1	0.05	24.9	<27.5	(<2.5)	65	(18)	–	–
Type 317	18.5	3.1	0.06	30.5	35	(1.7)	91	(33)	77	(25)
Alloy 904L	20.5	4.5	0.05	36.9	68	(20)	120	(49)	113	(45)
AL-6XN®	20.5	6.2	0.22	47.6	110	(43)	194	(90)	172	(78)

- 1 PRE_N = Cr + 3.3 Mo + 30N
- 2 Based on ASTM G-48B (6% FeCl₃ for 72 hours with crevices).
- 3 Based on ASTM G-48A (6% FeCl₃ for 72 hours).
- 4 Based on ASTM G-150 (1 M NaCl)⁵¹.

A familiar way of ranking stainless steels is "pitting potentials" as measured using an electrochemical apparatus in a standard chloride solution. The pitting potential indicates the relative susceptibility of an alloy to localized corrosion. The more positive the potential the less likely the alloy is to suffer pitting. Figure 3 shows that the chloride pitting resistance of AL-6XN alloy is far superior to 300 series austenitic stainless steels and to Alloy 904L. The data were obtained from anodic polarization tests conducted according to ASTM G-61 at a scan rate of 1.2 V/hr.

The temperature of a solution at which pitting is first observed, known as the critical pitting temperature (CPT), is another familiar way to rate the relative performance of stainless steels. CPT values have been determined in ferric chloride (10% FeCl₃·6H₂O)¹⁰ and in an acidic mixture of chlorides and sulfates (4% NaCl + 1% Fe₂(SO₄)₃ + 0.01 M HCl)¹⁴ as shown in Figure 4 and Figure 5 respectively. Note the significant difference in the CPT values for unwelded versus welded samples in Figure 4. This is discussed further on page 37: Corrosion of Welds.

Crevice Corrosion

The danger of corrosion occurring at crevices under deposits or gaskets or at joints between two metals is significantly greater than that of pitting on open surfaces. For this reason, crevice corrosion tests are generally more severe than pitting tests and are also more complicated to conduct and interpret. The results from several different test solutions and crevice configurations are presented.

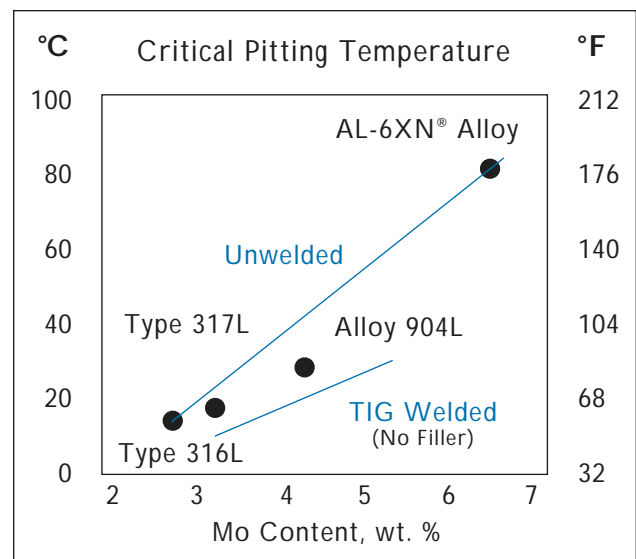

FIGURE 4: Critical pitting temperatures in ferric chloride solutions.¹⁰

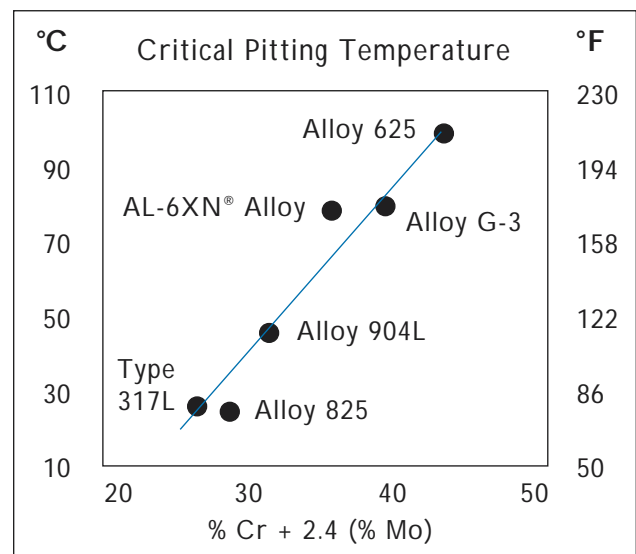
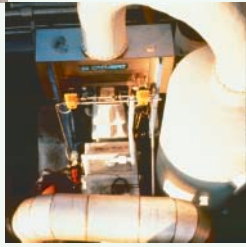

FIGURE 5: Critical pitting temperatures in an acidic mixture of chlorides and sulfates.¹⁴



Nitrogen, in cooperation with molybdenum, has a beneficial effect on crevice corrosion resistance in chloride-bearing, oxidizing, acid solutions. This effect is demonstrated in Figure 6 which shows a decrease in alloy weight loss in ASTM G48 Practice B with increasing alloy nitrogen content.

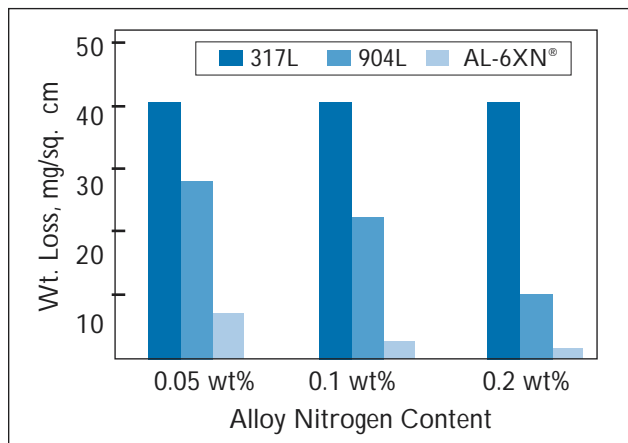

FIGURE 6: Crevice corrosion resistance in ferric chloride at 122°F (50°C).

Critical Crevice Corrosion Temperature (CCCT)

Tests that establish the temperature of a ferric chloride solution at which crevice corrosion is first ob-

served (referred to as the critical crevice corrosion temperature (CCCT)) are often used to compare the crevice corrosion resistance of various alloys. Such rankings have been shown to be consistent with data for exposures in natural seawater at ambient, temperature.^{15,16}

Critical crevice corrosion temperatures for various austenitic, ferritic and nickel-base alloys in ferric chloride solution are presented in Table 2. The AL-6XN alloy typically exhibits a CCCT value of 43°C (110 °F) in the fully annealed condition, which is superior to all other austenitic stainless grades and even certain nickel-base alloys. Crevice corrosion test results can vary considerably for different test practices; the details of a given test practice should be known when comparing data from different sources. The data in Table 2 were generated using the ASTM G-48B procedure.

Natural Seawater

The performance of alloys in seawater after a 60-day exposure with an inert crevice assembly is shown in Figure 7. The assembly was torqued to 8.5 Nm (6.3 ft-lb). Type 316 was severely attacked while the AL-6XN alloy was unaffected.

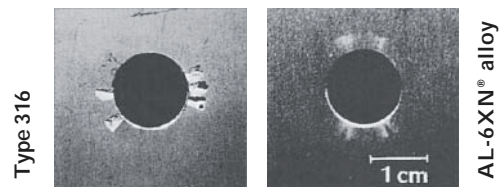

FIGURE 7: Samples exposed for 60 days in filtered seawater with multiple crevice washer assemblies.

Dissimilar Metal Crevices (DMC)

Corrosion tests involving metal-to-metal crevices in which one of the metals is actively corroding provide another means of assessing the relative resistance of alloys which may be more indicative in some situations of actual service performance than the standard ASTM G-48B test.^{17,34} The relative performance of certain alloys in tests with dissimilar metal crevices (DMC) is not the same as that with inert crevices. For example, AL-6XN alloy displayed greater resistance than superferritic stainless steels such as AL 29-4C®

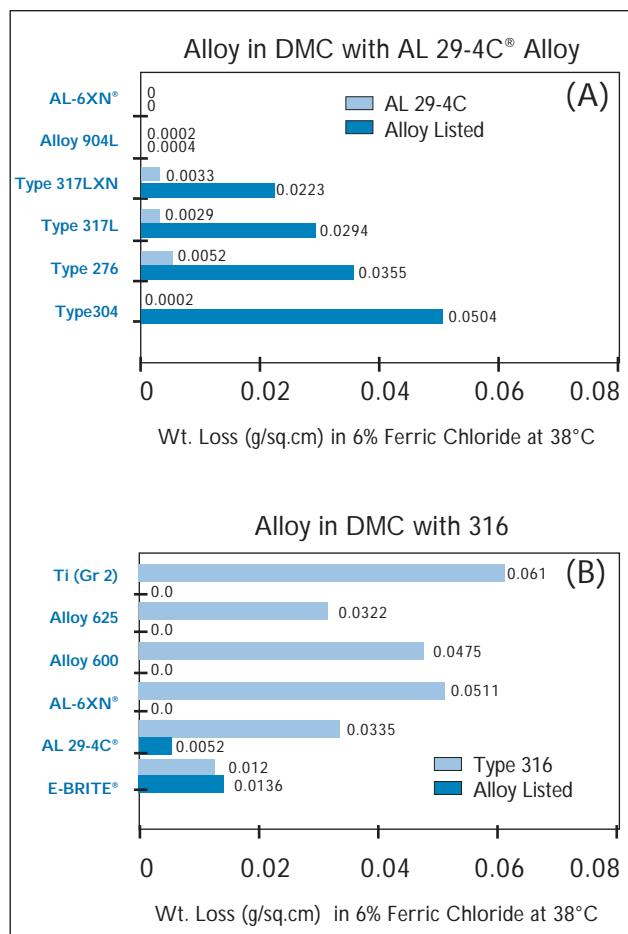

FIGURE 8: Corrosion of various alloys in dissimilar metal crevices with either AL29-4C® Alloy (A) or Type 316 (B).

alloy in DMC (Figure 8) but just the reverse is true in tests involving metal-to-nonmetal crevices (Table 2).

Effects of pH

Increasing the acidity of a solution can result in a dramatic increase in general corrosion rate below a critical value for a given alloy and environment. Such critical values, referred to as depassivation pH's, indicate relative resistance to general and crevice corrosion. Figure 9 shows corrosion rates in acidified 3.5% sodium chloride solution at room temperature for certain austenitic and ferritic stainless alloys. AL-6XN alloy was the most resistant of the austenitic stainless alloys tested in this study, and did not break down (i.e., corrosion rates increase by more than two orders of magnitude) until the solution acidity was below pH 0.3.

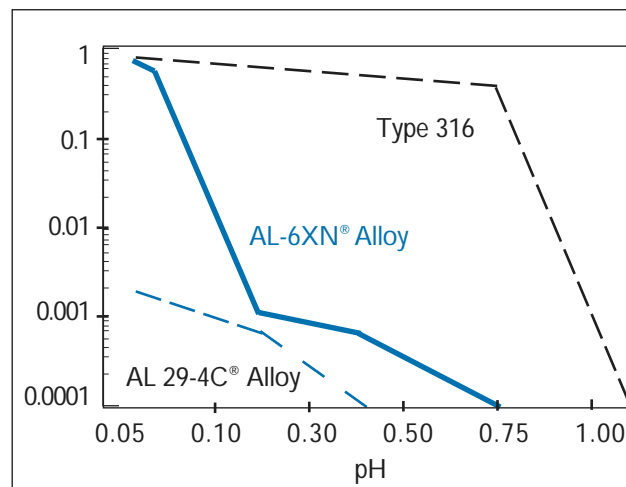

FIGURE 9: Effect of pH on alloys in NaCl solutions.

Galvanic Compatibility

Unless a system is constructed entirely from AL-6XN alloy, precautions must be taken to avoid galvanic corrosion. Predicting the galvanic interaction of a couple is much more complex than comparing free corrosion potentials in a given environment, as shown in Figure 10. The polarization resistance and area ratio of the dissimilar materials are often more important. AL-6XN alloy demonstrates a considerably more positive free corrosion potential than conventional stainless steels in seawater. In addition, the potentials of stainless alloys while passive are significantly higher than those when actively corroding.

Tests involving the actual environmental conditions and geometries of the various components are best for assessing galvanic compatibility. Such tests were performed for the AL-6X alloy condenser tubes in contact with various tube sheet materials.^{18,19} Based on the results of this study, AL-6XN alloy would not be expected to suffer accelerated corrosion by galvanic contact with any other metals or alloys typically used to resist seawater. However, the following would be expected to happen to various metals and alloys when coupled with AL-6XN alloy and exposed to quiescent seawater:

- Galvanic corrosion of copper alloys
- Dezincification of Muntz metal
- Galvanic corrosion of mild steel
- Compatibility with all area ratios of titanium, 6% Mo and nickel-base alloys

The presence of biofilms may increase the effect of galvanic coupling⁵⁰.

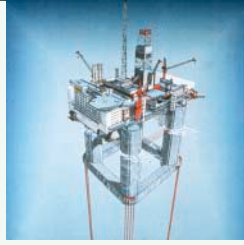

Intergranular Corrosion (IGC)

Intergranular corrosion (IGC) of stainless steels is usually due to sensitization caused by the precipitation of chromium carbides at grain boundaries and the concurrent development of chromium-depleted grain boundaries. Since AL-6XN alloy is an "L" grade containing less than 0.03 wt% C, carbide precipitation is unlikely; but it can be sensitized by precipitation of the intermetallic sigma phase. Such intermetallic precipitation can be detected metallographically (see Appendix C) or by corrosion testing.

The Huey test (65% boiling nitric acid, ASTM A 262 Practice C) is a common test for IGC resistance of austenitic stainless steels, but the Huey test is unsuitable for evaluating molybdenum-bearing austenitic stainless alloys. The reason for this is that hot, concentrated nitric acid is extremely corrosive to molybdenum-containing alloys even when they do not contain a significant content of chromium-rich intergranular precipitates.²⁰ For similar reasons, the standard oxalic acid etch test (ASTM A 262 practice A) is also unsuitable for use with AL-6XN alloy and other high molybdenum stainless steels. Consequently, relative to a non-molybdenum-bearing austenitic stainless alloy, the corrosion rates are not indicative of the presence of intergranular phases. The following tests have been used for evaluating the IGC resistance of AL-6XN alloy:

- A 262-86 practice D (*nitric-hydrofluoric*)
- A 262 practice E (*copper-copper sulfate-16% sulfuric acid*)
- A 262 practice F (*copper-copper sulfate-50% sulfuric acid*)
- Boiling 50% sulfuric acid
- G 28 practice A (*ferric sulfate-50% sulfuric acid; equivalent to A-262 B.*)
- G 28 practice B (*23% sulfuric acid-1.2% hydrochloric acid-1% ferric chloride-1% copper chloride*)

The ASTM G28 practice A test and the A 262 practice E, or F tests are usually the most suitable for use with AL-6XN alloy. Typical rates for these tests are shown in Table 9. Also note that the ferric chloride test described previously has been found to be a sensitive indicator of the presence of deleterious intergranular phases.

Volts vs. SCE

Volts vs. SCE	Material
-1.60	Magnesium
-1.00	Zinc
-0.95	Aluminum
-0.70	Cadmium
-0.60	Steel
-0.50	Type 304 (Active)
-0.40	Type 316 (Active)
-0.35	Naval Brass
-0.30	Muntz Metal
-0.30	Copper
-0.30	Managnese Bronze
-0.25	90-10 Cu-Ni
-0.20	70-30 Cu-Ni
-0.20	Lead
-0.15	Nickel
-0.10	Type 304 (Passive)
-0.05	Type 316 (Passive)
0.00	E-BRITE® Alloy
0.00	AL 29-4C® Alloy
0.00	AL-6XN® Alloy
0.05	Alloy 625, Alloy 276
0.10	Titanium
0.25	Graphite

Active

Noble

FIGURE 10: Galvanic series in seawater.

General Corrosion

In contrast to localized forms of corrosion, general corrosion is rather predictable. The uniform attack of an entire area exposed to a corrosive environment is usually expressed in terms of an average loss-of-metal-thickness for a given period of time in units of mils per year (mpy), inches per month (ipm) or millimeters per year (mm/y). The following criteria are general guidelines for selecting corrosion resistant alloys:

Table 8 contains the results of immersion tests conducted according to ASTM G-31. Seven different boiling acid and alkali solutions were used to compare the performance of different alloys in a variety of solutions rather than to simulate a particular process industry environment. Duplicate samples were exposed for five 48-hour periods and an average corrosion rate was determined.

According to the previously stated rating criteria, the performance of the AL-6XN alloy is excellent in acetic, formic and phosphoric acids; satisfactory in oxalic acid and sodium hydroxide; useful in sodium bisulfate; and poor in boiling 10% sulfuric acid. Overall the alloy is comparable to Alloy 904L and Alloy 276 and better than Type 316L and Type 317L in the boiling test solutions shown in Table 8. AL-6XN alloy had rates that were an order of magnitude less than those for Alloy 276, and similar to Type 316L, Type 317L and Alloy 904L in the ASTM A 262 tests shown in Table 9.

Increasing the molybdenum and nickel contents of austenitic alloys improves resistance to reducing and non-oxidizing acids, such as sulfuric (H_2SO_4), phosphoric (H_3PO_4), hydrochloric (HCl) and formic (HCOOH) acids. Chromium improves resistance in less aggressive solutions of HCl, H_2SO_4 and H_3PO_4 .

The resistance of AL-6XN alloy to dilute (<15%) sulfuric acid at all temperatures up to the boiling point and to concentrated (>85%) solutions at low temperatures is good for an austenitic stainless alloy; this is because of the high molybdenum and nickel contents. Contaminants such as iron, copper and chromium ions, which are usually present in pickling and plating solutions, actually lower the corrosion rate of the alloy in sulfuric acid.

The 4 mpy (0.1 mm/y) isocorrosion lines for the AL-6XN alloy and other alloys in pure sulfuric acid are shown in Figure 11. AL-6XN alloy is considerably more

TABLE 8: Corrosion resistance in boiling solutions.

ASTM G-31 Test Solution (Boiling)	Corrosion Rate in Mils per Year (mm/y) for Cited Material				
	Type 316L	Type 317L	Alloy 904L	AL-6XN®	Alloy 276
20% Acetic Acid	0.12 (0.003)	0.48 (0.01)	0.59 (0.02)	0.12 (0.003)	0.48 (0.01)
45% Formic Acid	23.41 (0.60)	18.37 (0.47)	7.68 (0.20)	2.40 (0.06)	2.76 (0.070)
10% Oxalic Acid	44.90 (1.23)	48.03 (1.14)	27.13 (0.69)	7.32 (0.19)	11.24 (0.28)
20% Phosphoric Acid	0.60 (0.02)	0.72 (0.02)	0.47 (0.01)	0.24 (0.006)	0.36 (0.009)
10% Sodium Bisulfate	71.57 (1.82)	55.76 (1.42)	8.88 (0.23)	4.56 (0.12)	2.64 (0.067)
50% Sodium Hydroxide	77.69 (1.92)	32.78 (0.83)	9.61 (0.24)	11.4 (0.29)	17.77 (0.45)
10% Sulfamic Acid	124.3 (3.16)	93.26 (2.39)	9.13 (0.23)	9.36 (0.24)	2.64 (0.067)
10% Sulfuric Acid	635.7 (16.15)	298.3 (7.58)	100.8 (2.53)	71.9 (1.83)	13.93 (0.35)

TABLE 9: Corrosion resistance in boiling solutions.

ASTM A262 Test Solution (Boiling)	Corrosion Rate in Mils per Year (mm/y) for Cited Material				
	Type 316L	Type 317L	Alloy 904L	AL-6XN®	Alloy 276
Practice B	25.81	20.58	14.04	15.35	262.2
($Fe_2(SO_4)_3$ - H_2SO_4)	(0.656)	(0.523)	(0.357)	(0.390)	(6.66)
Practice C	22.12	19.51	15.23	26.2	900.1
(65% HNO_3)	(0.562)	(0.496)	(0.387)	(0.666)	(22.86)
Practice E	PASS	PASS	PASS	PASS	PASS
(Cu-CuSO ₄ -H ₂ SO ₄)	PASS	PASS	PASS	PASS	PASS
Practice F	106.0	99.0	91.8	74.2	275.5
(Cu-CuSO ₄ -H ₂ SO ₄)	(2.69)	(2.51)	(2.33)	(1.88)	(7.00)



resistant than Type 316 and somewhat better than Alloy 904L. The performance of AL-6XN alloy is similar to that of the more costly materials that are often used in sulfuric acid, such as Alloy 20 and Alloy 825. AL-6XN alloy also has excellent resistance in sulfuric acid contaminated by chlorides (Figure 12).

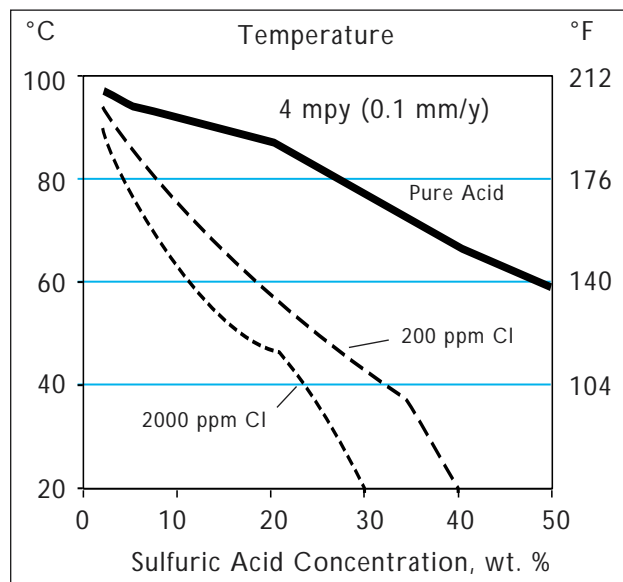

FIGURE 12: Isocorrosion lines for AL-6XN[®] alloy in chloride-contaminated sulfuric acid.

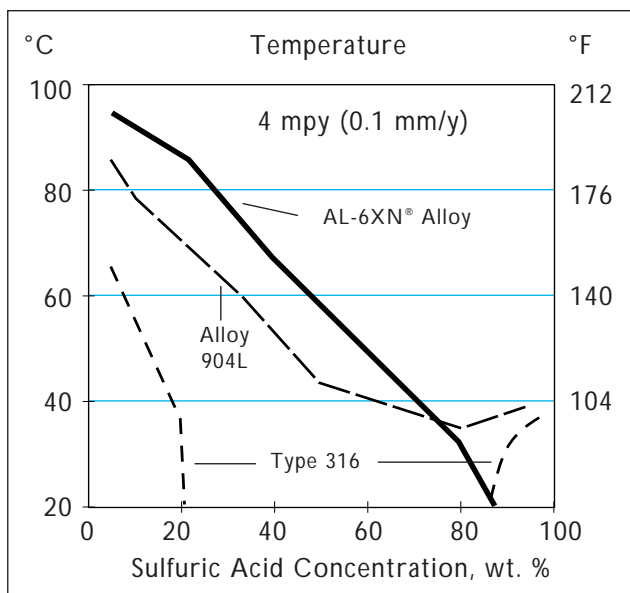

FIGURE 11: Isocorrosion lines for alloys in pure sulfuric acid.

NOTE: The data behind these isocorrosion plots were generated using deliberate activation of the test coupons. This activation destroys metastable passivity and provides conservative data for design use. Caution should be exercised when comparing these data with data from other studies, where activation may not have been performed.

Pure phosphoric acid is much less corrosive than sulfuric acid to stainless alloys. However, the superior resistance of AL-6XN alloy is required in process streams that contain halide impurities. An isocorrosion diagram for AL-6XN alloy in pure phosphoric acid is shown in Figure 13. AL-6XN alloy is resistant to phosphoric acid concentrations above 45% where Alloy 20 and Alloy 825 are typically required. Therefore, AL-6XN alloy is an economical alternative to more costly high nickel alloys in concentrated phosphoric acid.

Austenitic stainless steels remain passive in dilute HCl solutions at low temperatures only. Type 316 and Alloy 904L cannot be used in hydrochloric acid because of the risk of localized and general corrosion. As shown in Figure 14, the temperature of the HCl solutions that resulted in equivalent corrosion rates was significantly higher for AL-6XN alloy than Alloy 904L. The AL-6XN alloy should only be considered for use in dilute HCl at low temperatures. There is little risk of pitting corrosion of AL-6XN alloy in the zone below the critical line, but crevices must be avoided.

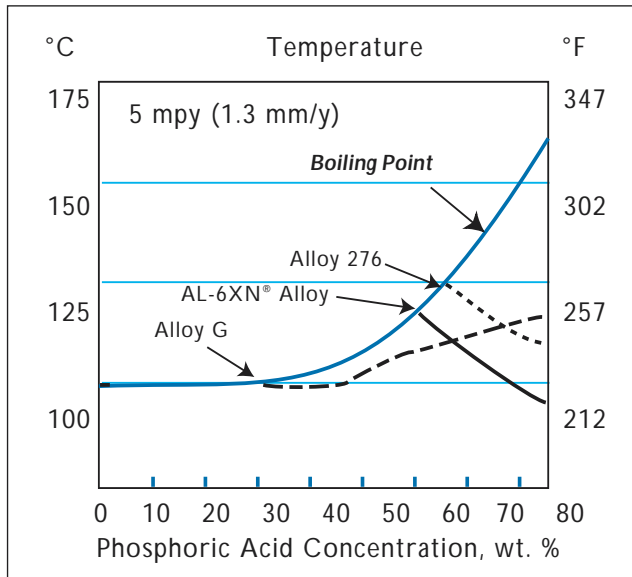

FIGURE 13: Isocorrosion lines for AL-6XN® alloy in pure phosphoric acid.

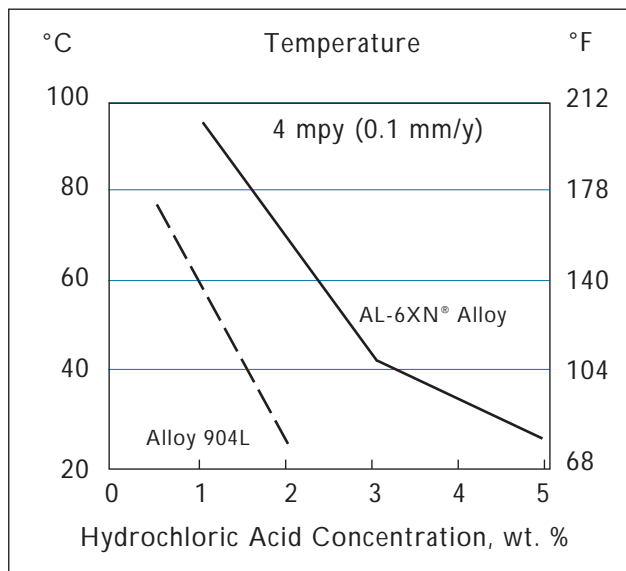

FIGURE 14: Isocorrosion diagram for alloys in pure dilute hydrochloric acid.

The effects of various alloying elements on the polarization behavior of an Fe-Cr-Ni-Mo alloy, like AL-6XN alloy, when exposed to an acid chloride solution, like HCl, are shown schematically in terms of an anodic polarization diagram in Figure 15. Nitrogen alloying decreases the passive current density (i_p) and increases the primary passive potential (E_{pp}), which has a net effect of expanding the range of potentials for which the alloy remains passive. As the nitrogen content of

the Fe-Cr-Ni-Mo alloy is increased, the critical corrosion current density (i_{corr}) shifts toward more active potentials and lower current densities.

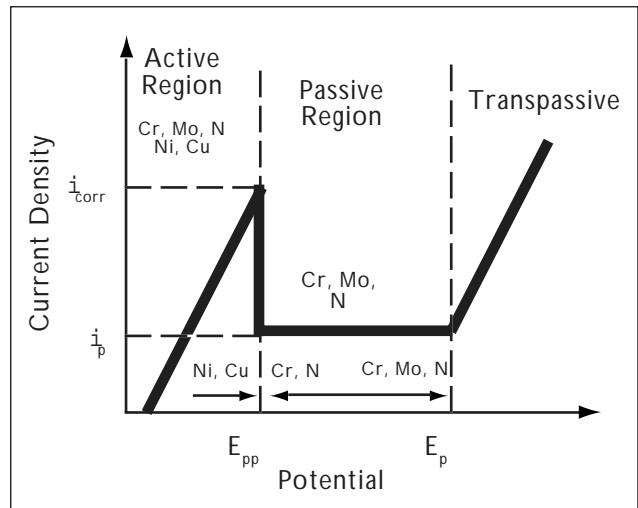
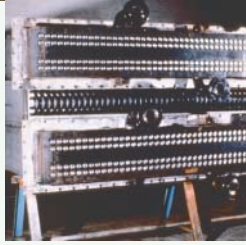
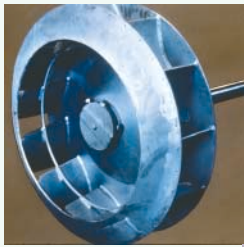

FIGURE 15: Schematic anodic polarization diagram for an Fe-Cr-Ni-Mo alloy in an acid chloride solution.

Caustic and Alkaline-Salt Solutions

Stainless and nickel-base alloys behave differently in strong acids and alkalis that contain impurities. Oxidants such as NO_3^- , $\text{Cr}_2\text{O}_7^{2-}$, MnO_4^- , Fe^{+3} , Cu^{+2} and O_2 have a detrimental effect on the behavior of nickel and nickel-base alloys in caustic solutions. The chromium content of alloys containing more than residual levels of nickel is crucial in determining corrosion rates in pure sodium hydroxide environments.²¹ Comparative data for AL-6XN alloy in 50% sodium hydroxide and in 10% sodium bisulfate solutions are presented in Table 8. Overall, the AL-6XN alloy performs well for an austenitic stainless alloy in hot caustic solutions containing chlorine and sulfur compounds as shown in Figure 16.



Stress-Corrosion Cracking (SCC)

Although the stainless steels used in the Chemical Process Industry (CPI) typically experience some general corrosion attack, the majority of actual failures are due to localized corrosion. One of the most serious forms of localized corrosion is stress-corrosion cracking (SCC). Increasing the nickel and, in some cases, the molybdenum content of austenitic alloys has been shown to improve resistance to SCC. The effect of alloy nickel content is represented by Figure 17 in which the behavior of AL-6XN alloys is superimposed on the familiar Copson curve.²² Figure 17 also shows that alloy molybdenum contents above 2% tend to decrease the susceptibility of conventional austenitic stainless steels to chloride SCC.²³

The behavior of various alloys in standard test solutions is described in Table 10. AL-6XN alloy has demonstrated immunity to SCC in tests conducted, per ASTM G36, for up to 2,200 hours in boiling 26% NaCl, seawater, saturated sea-salt brine, and 50% NaOH solutions (one atmosphere total pressure). This demonstrates the superiority of AL-6XN alloy over standard 300 series austenitic stainless steels. AL-6XN alloy cracks in boiling 33% LiCl solution or 42% MgCl₂ solutions. These are extremely severe tests which will crack even highly SCC-resistant alloys. Only alloys with more than 50% nickel routinely demonstrate SCC resistance in them. It should be remembered that increased temperatures and reduced pH generally increase the probability of SCC. These factors must be considered when choosing an alloy for SCC resistance in a particular environment.

TABLE 10: Autoclave Testing of AL-6XN® alloy in NaCl Solutions

Test Solution (wt. %)	Test Temp.	Exposure Time	Results
0.002 % Cl	288°C	1010 hours	No cracking
0.02 % Cl	288°C	510 hours	Three of six cracked
0.02 % Cl	260°C	1008 hours	No cracking
0.2 % Cl	204°C	1011 hours	No cracking
0.2 % Cl	232°C	504 hours	Two of six cracked
0.2 % Cl	260°C	504 hours	Four of six cracked
15.8% Cl	121°C	1011 hours	No cracking
15.8% Cl	149°C	1005 hours	One of four cracked
15.8% Cl	177°C	480 hours	Two of four cracked
15.8% Cl	204°C	1088 hours	One of four cracked
15.8% Cl	260°C	1008 hours	Three of five cracked

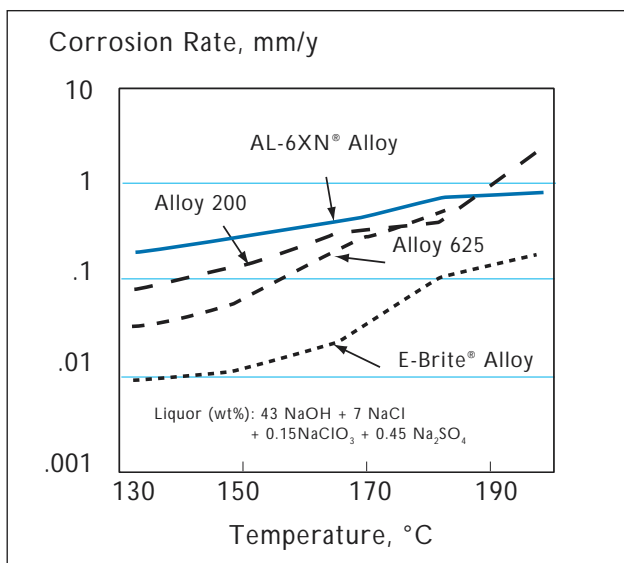

FIGURE 16: Corrosion rates of austenitic alloys in a simulated caustic evaporator liquid.

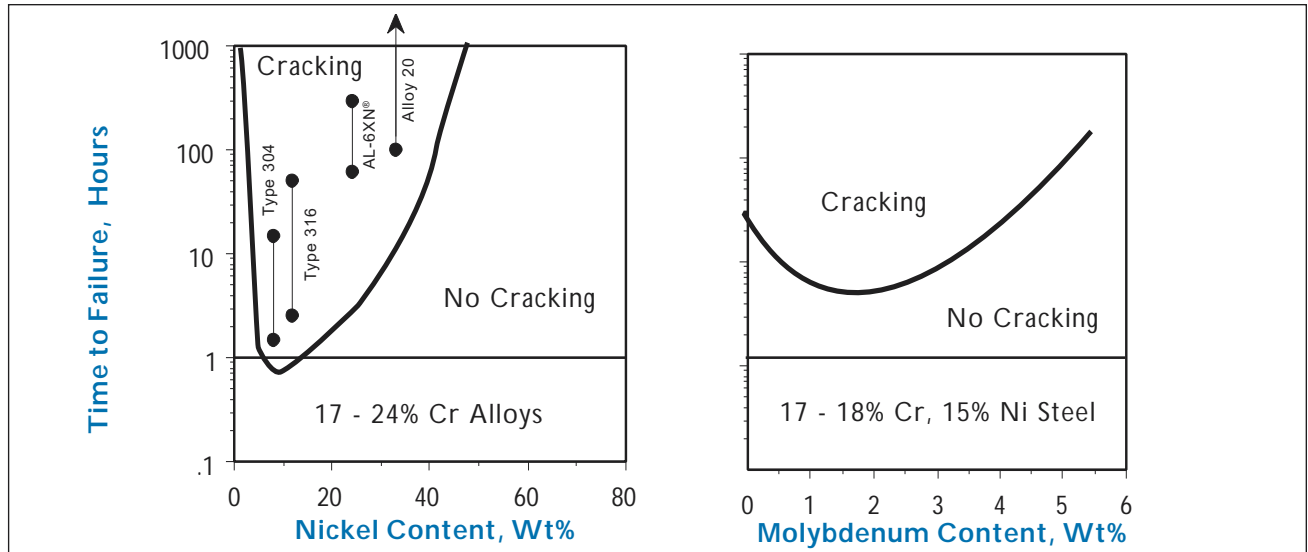

FIGURE 17: Effect of nickel (left) and molybdenum (right) on SCC resistance in boiling magnesium chloride solutions.

Because the AL-6XN alloy has increased resistance to SCC it has been used successfully in applications such as chemical process equipment, brewery equipment, feed-water heaters, and flue gas reheaters. Since the alloy is not completely immune to SCC there have been occasional instances of cracking in chloride environments at higher temperatures (>150 °C).

To better define the SCC resistance of AL-6XN alloy, U-bend specimens of N08367 were prepared and tested in an autoclave. Three to six specimens were tested per condition. The results of this testing are summarized in Table 10 and Figure 18.

AL-6XN alloy is very resistant to SCC at temperatures less than 121°C. The threshold temperature for

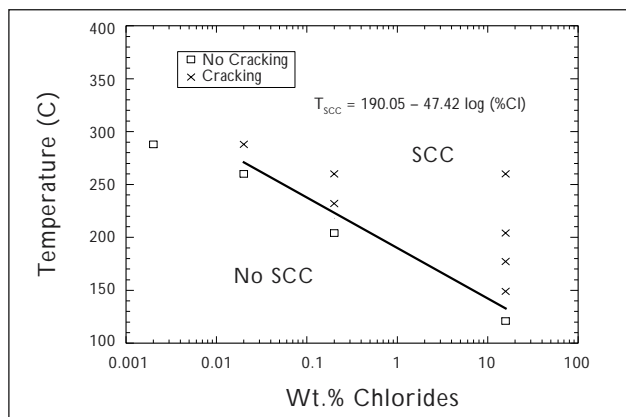

Figure 18. Stress Corrosion Cracking Threshold Temperature for AL-6XN® Alloy in Neutral Chloride Solutions.

initiating SCC increases with decreasing chloride content. The threshold temperature (T_{SCC}) for cracking can be defined as;

$$T_{SCC} = 190.05 - 47.42 \log (\%Cl)$$

These results indicate that it is unlikely that AL-6XN alloy will crack in neutral sodium chloride solutions at atmospheric boiling temperatures (~100°C). However, caution must be used when specifying this alloy for applications where temperatures could be greater than 121 °C.

Cracking can occur in environments with chloride contents as low as 0.02% (200 ppm) if the temperature is greater than 260°C. Hence, with higher temperature environments (>120°C) one must consider the maximum chloride content that could potentially be encountered. This often is not readily apparent for many applications due to wet/dry interfaces or process start-ups or shutdowns that can locally concentrate chloride contents.

TABLE 11: Chloride SCC resistance in standard U-bend tests. (Exposure to 1,000 hours).

Performance for Cited Boiling Solutions and Test Periods			
Alloy	42% MgCl ₂	33% LiCl	26% NaCl
Type 316	Fail	Fail	Fail
Alloy 904L	Fail	Fail	Pass
AL-6XN®	Fail	Fail	Pass
Alloy 625	Pass	Pass	Pass



Microbially Influenced Corrosion (MIC)

Although MIC has been studied for over seventy years, the full impact of microorganisms on the degradation of metallic structures has only recently begun to be appreciated in many industries. Corrosion rates have been observed to increase by two and three orders of magnitude due to the activity of microbes and deposits on metal surfaces. A review of service experiences with stainless steels has concluded that no instances of MIC have been reported for 6% Mo alloys⁴².

MIC is not a new form of corrosion, but some of the conditions created by microbes are unique. Microbes can directly participate in electrochemical reactions that make an environment much more corrosive. Certain microbes can metabolize nutrients using oxygen or other chemical compounds (e.g., sulfur and iron) and generate corrosive agents (e.g., organic acids and sulfides) as well as create a "living crevice." The mechanism for MIC is related to that for crevice corrosion. MIC is often associated with biofouling. Deposits of gelatinous slime and other debris can cover an otherwise open surface and effectively increase the potential at the surface by as much as 400 mV. In such cases, a passive metal surface is prone to attack at localized sites where bare metal is exposed through the fouling layer.

The three major types of microbes commonly associated with MIC are sulfate reducing bacteria (SRB), iron and manganese bacteria and sulfur oxidizing bacteria. Iron and manganese oxidizing bacteria are the types most often associated with the corrosion of stainless steels. Such bacteria produce iron and manganese metabolites that form deposits. Temperatures greater than 40°F (4°C) but less than 140°F (60°C) tend to promote MIC.

AL-6XN alloy is superior to Type 316 in a laboratory immersion test that chemically simulates an environment created by bacteria that concentrate manganese on heat exchanger tubing cooled by river water that has been chlorinated to prevent biofouling (Table 12).²⁵ A simple immersion test does not simulate the dynamics of microbial consortia in actual service environments. However, reliable methods for predicting the susceptibility of materials to MIC have yet to be developed.

Microbial growths can be controlled by chemical treatments, rigorous monitoring and maintenance. In certain cases, highly oxidizing biocides such as chlorine can elevate the potential of a system to a level that might induce corrosion of the metal surfaces that are being cleaned.

The primary criterion for replacement materials should be the avoidance of localized attack. The AL-6XN alloy offers significant levels of resistance to pitting and crevice corrosion induced by microbes or highly oxidizing, halide-containing biocides, such as chlorine, and inhibitors. The alloy is also hard and tough, allowing it to withstand the abrasion and vibration associated with abrasive cleaning.

TABLE 12: Resistance to a simulated MIC environment (2% NaCl + KMnO₄). Results of duplicate specimen testing.

Temp. °F (°C)	Weight Loss, mg/cm ²			
	77°F (25°C)	122°F (50°C)	167°F (75°C)	194°F (90°C)
Alloy				
Type 316	0.01 (0.02)	0.03 (0.04)	6.99* (0.12)	–
AL-6XN®	0.01 (0.01)	0.03 (0.03)	0.06 (0.05)	0.04 (0.03)

* Pitting was observed

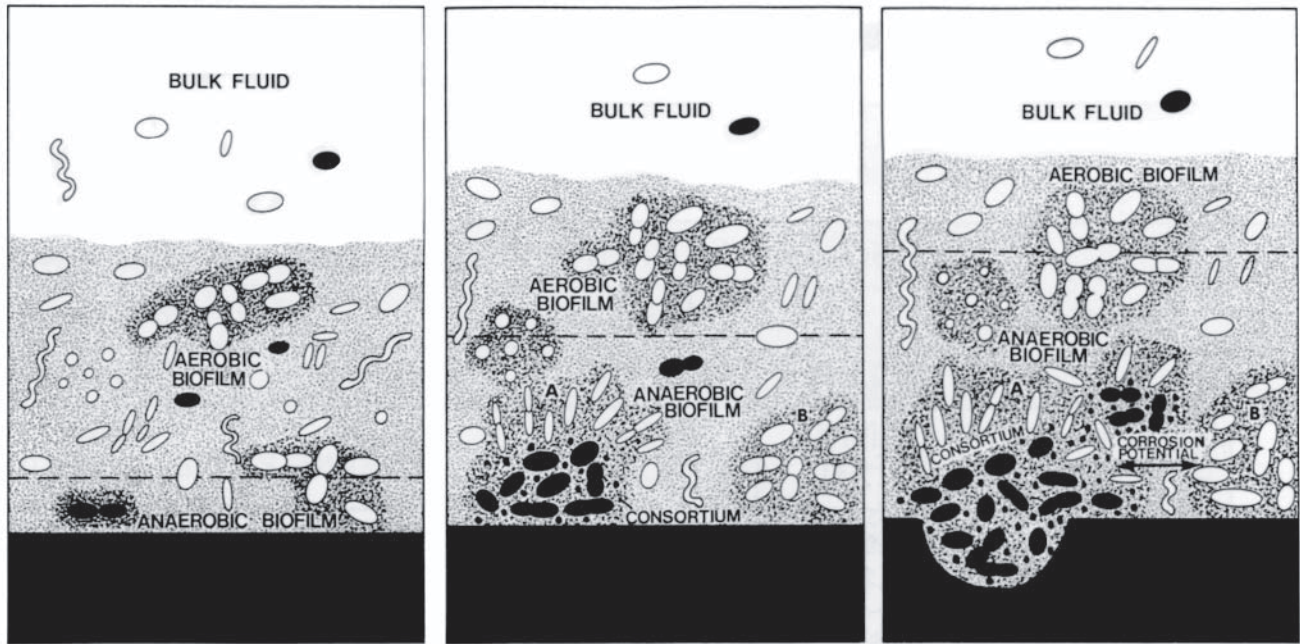

FIGURE 19: Development of Microbial Consortia ¹⁴.

Erosion Corrosion

In a program conducted in the late 1970s,²⁶ AL-6X alloy was found to resist erosion damage even when exposed for 30 days to an extreme seawater flow velocity of 129 ft/sec (39 m/sec) at 9°C (48°F). Under comparable conditions the erosion corrosion rates for other materials are listed in Table 13. AL-6XN alloy, which is a general improvement over the AL-6X alloy, has been successfully used as tubing in power plants with water velocities in excess of 8 feet/sec (2.4 m/sec).

TABLE 13: Erosion corrosion resistance of alloys in seawater flowing at 125-140 ft/sec (39-40 m/sec). ²⁶

Alloy	Corrosion Rate *	
	mm/yr	mils/yr
Type 304	0.025	1
Type 316	0.025	1
AL-6X™	0.025	1
90:10 Cu-Ni	0.63	25
6061 Aluminum	1.6	65
Carbon Steel	3.8	150

* 30-Day exposures in natural seawater at 48-59°F (9-15°C)

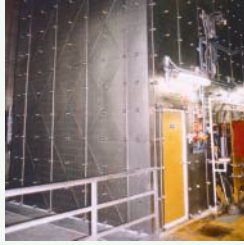

Physical Properties

The physical properties of the AL-6XN alloy are similar to those of other austenitic stainless steels (Table 14). The elastic modulus values of AL-6XN alloy are lower than those for Type 316L and Alloy 625. However, these modulus values are high in comparison to other non-ferrous alloys, such as titanium (15×10^6 psi). Consequently, AL-6XN alloy, unlike titanium, can replace copper alloy condenser tubing without the need for modifying the condenser design or adding additional support plates to avoid vibration damage. The thermal conductivity and coefficient of expansion values are lower than those for Type 316L but are higher than Alloy 625. Although the thermal conductivity of AL-6XN alloy is significantly lower than that for copper-base alloys, studies have shown that the thermal conductivity of the tube wall accounts for only about 2% of the total heat transfer resistance in steam condenser service⁴⁶.

AL-6XN alloy has a stable face-centered cubic crystal structure similar to other austenitic stainless alloys. The AL-6XN alloy is non-magnetic. Its magnetic permeability remains low even after severe cold forming. Typical physical properties of AL-6XN alloy are presented in Tables 16, 17 and 18.

PHYSICAL PROPERTIES

Mechanical Properties

Annealed Condition

Fatigue properties

Welded Condition

Heat Treatment

Open-Air Annealing

Catastrophic Oxidation

Bright Annealing

Forming

Hot Forming

Warm Forming

Cold Forming

Tube Forming

Machinability

Cutting

TABLE 14: Comparison of physical properties.

Alloy	Elastic Modulus		Thermal Conductivity at 212°F (100°C)		Expansion Coefficient from 77 to 212°F	
	psi x 10 ⁶	GPa	Btu/hr·ft·°F	W/mk	10 ⁻⁶ /°F	10 ⁻⁶ /°C
Type 316	29.0	200	9.2	16.0	8.5	15.3
90:10 Cu-Ni	18.0	124	26.0	45.0	9.3	16.8
70:30 Cu-Ni	22.0	152	17.0	29.4	8.5	15.4
Titanium	15.0	103	9.5	16.4	5.0	9.1
Alloy 904L	28.3	195	7.6	13.2	8.3	15.0
AL-6XN®	28.3	195	7.5	13.0	7.9	14.2
Alloy 625	29.7	205	6.2	10.7	7.1	12.8

TABLE 15: Physical properties of AL-6XN[®] Alloy at room temperature.

Property	Value	Units
Density	0.291 8.06	lb/in ³ g/cm ³
Modulus of elasticity	28.3 x 10 ⁶ 195	psi GPa
Melting Range	2410 to 2550 1320 to 1400	°F °C
Thermal Conductivity		
68 to 212°F	6.8	Btu/hr•ft•°F
20 to 100°C	11.8	W/mk
Coefficient of Expansion		
68 to 212°F	8.5	10 ⁻⁶ /°F
20 to 100°C	15.3	10 ⁻⁶ /°C
Specific Heat Capacity	0.11 500	Btu/lb•°F J/kg•K
Electrical Resistivity	535 0.89	Ohm•circ mil/ft μΩ cm
Magnetic Permeability		
Fully annealed 0.5" plate	1.0028	Oersted
65% cold-worked plate	1.0028	(μ at 200H)
Scaling Temperature	1885 1030	°F °C

TABLE 17: Effect of Temperature on AL-6XN[®] Alloy Physical Properties

Temp °C	Temp °F	Specific Heat (BTU/lb•°F)	Specific Heat (J/kg•K)	Thermal Diffusivity (cm ² /s)
21	70	0.113	474	0.0305
100	212	0.118	492	0.0331
200	392	0.123	514	0.0364
300	572	0.128	536	0.0395
400	752	0.133	557	0.0423
500	932	0.138	578	0.0447
600	1112	0.146	610	0.0473
700	1292	0.149	622	0.0494
800	1472	0.151	633	0.0512
900	1652	0.153	642	0.0530
1000	1832	0.156	651	0.0542
1100	2012	0.158	660	0.0554
1200	2192	0.160	668	0.0563
1300	2372	0.162	676	0.0573

TABLE 16: Effect of Temperature on AL-6XN[®] Alloy Physical Properties

Temp °F	Thermal Expansion* (10 ⁻⁶ /°F)	Thermal Conductivity (BTU/hr•ft•°F)	Temp °C	Thermal Expansion* (10 ⁻⁶ /°C)	Thermal Conductivity (W/m•K)
200	7.84	7.50	93	14.11	12.98
400	8.36	8.76	204	15.05	15.16
600	8.59	10.03	316	15.46	17.36
800	8.75	11.23	427	15.75	19.43
1000	8.96	12.55	538	16.13	21.72
1200	9.24	13.91	649	16.63	24.07
1400	9.45	14.76	760	17.01	25.55
1600	9.61	15.64	871	17.30	27.07
1800	9.77	16.32	982	17.59	28.25
2000	9.93	17.26	1093	17.87	29.87
2200	10.12	17.52	1204	18.22	30.32
2400	10.35	18.10	1316	18.63	31.33

*Mean coefficient from 70°F (21°C) to temperature indicated

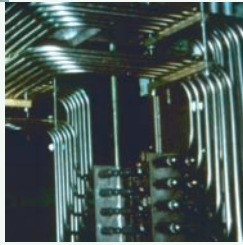

MECHANICAL PROPERTIES

Annealed Condition

Fatigue Properties

Welded Condition

Mechanical Properties

Annealed Condition

In comparison to more conventional austenitic stainless steels, the AL-6XN alloy is much stronger with comparable ductility. Table 19 shows typical transverse tensile properties at room temperature for AL-6XN sheet 0.026 to 0.139 inches (0.66 to 3.53 mm) thick in comparison to other austenitic stainless flat rolled products. The hardness of the alloy is relatively high (typically 88 RB) and the alloy work hardens in a manner similar to other stable austenitic stainless steels (Figure 20).

The AL-6XN alloy also demonstrates excellent toughness even at subzero temperatures. Table 20 presents values for standard size Charpy V-notch specimens that were held at very low temperatures for one hour prior to impact testing.

The strength of the AL-6XN plate is maintained at elevated temperatures (Figure 22). The ASME maximum allowable values of tensile stress for AL-6XN alloy and other austenitic alloys in the form of sheet or strip that is less than 3/16 inches (4.8 mm) thick appear in Figure 23.

TABLE 19: Typical tensile properties for austenitic stainless alloy sheet.

Properties at Room Temperature	Type 316	Alloy 904L	AL-6XN® Alloy
Yield Strength, ksi (MPa) (0.2% Offset)	45 (310)	42 (290)	53 (365)
Ultimate Tensile Strength ksi (MPa)	88 (607)	86 (593)	108 (744)
% Elongation in 2" (51 mm)	57	43	47
Hardness Rockwell B (Rockwell 30T)	81 (65)	79 (63)	88 (73)

**TABLE 18: AL-6XN® alloy (UNS N08367)
Modulus of Elasticity in Tension**

Temp °F	Temp °C	Modulus 10 ⁶ psi	Modulus MPa
75	24	28.3	195
200	93	27.4	189
400	204	26.1	180
600	316	24.8	171
800	427	23.4	161
1000	538	22.1	152

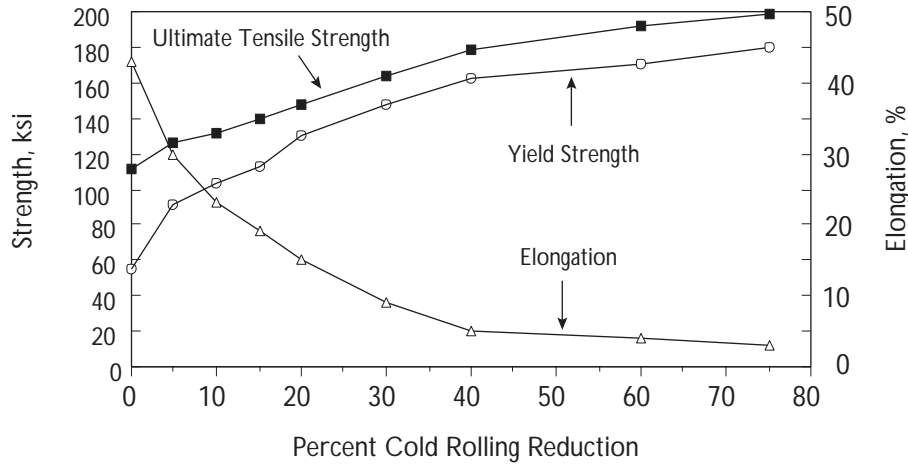

FIGURE 20: Effect of cold work on the tensile properties of the AL-6XN alloy.

TABLE 20: Low temperature properties of AL-6XN alloy.

Test Temperature °F	°C	Charpy Impact Toughness		Yield Strength ksi	Tensile Strength ksi	Elongation in 2" %	Reduction in Area %	Hardness Rb
		ft-lbs	joules					
70	21	140	190	53	108	47	75	88
-200	-129	100	135	–	–	–	–	–
-320	-196	85	115	107	196	49	64	–
-450	-267	*K _{Ic} 322	*K _{Ic} 353	142	218	36	51	–

* fracture toughness

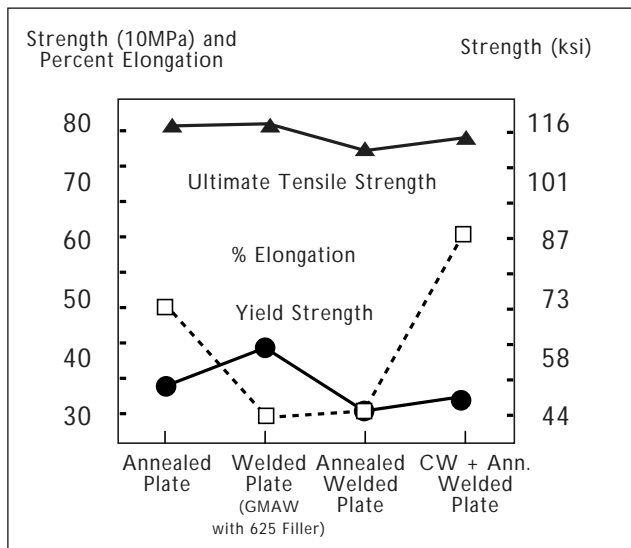

FIGURE 21: Tensile properties of 0.375" thick AL-6XN plate at room temperature.

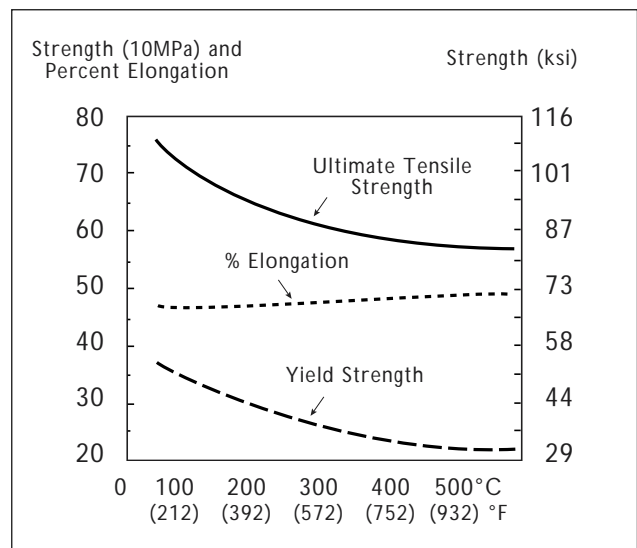

FIGURE 22: Tensile properties of 1 inch (25mm) thick AL-6XN plate at elevated temperatures.



Fatigue Properties

Results of bending fatigue tests of 0.027 inch (0.7 mm) thick AL-6XN alloy are shown in Figure 24. In the transverse direction, the endurance limit (10^7 cycles) for strip of 115 ksi (793 MPa) tensile strength is approximately 34.5 ksi (238 MPa). This is 30% of the tensile strength, a typical ratio for an austenitic stainless steel. Fatigue strength in the longitudinal (rolling) direction is slightly greater.

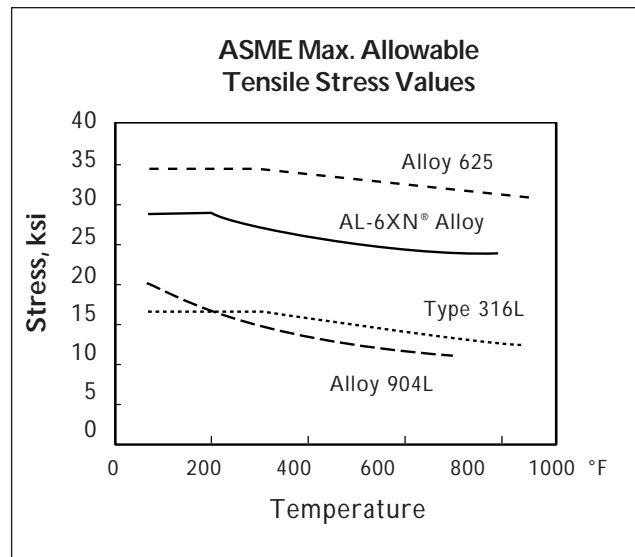

FIGURE 23: ASME maximum allowable stress values in tension for sheet or strip that is less than 3/16 inch (0.48 cm) thick.

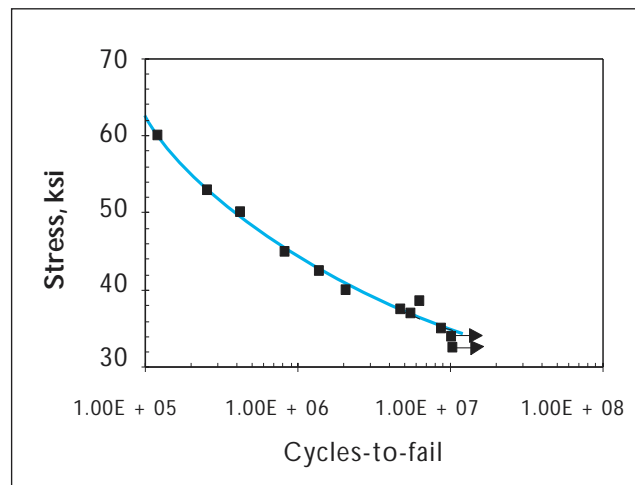

FIGURE 24: Bending fatigue resistance of 0.027 inch (0.7 mm) thick AL-6XN® alloy strip at room temperature.

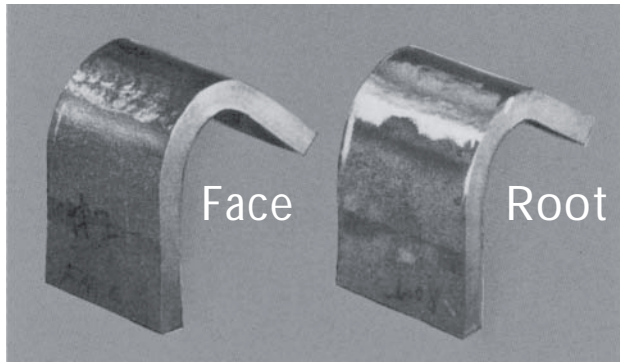
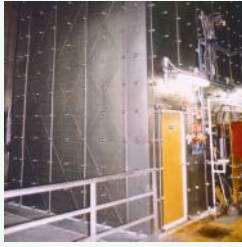

FIGURE 25: Bend test samples of AL 6XN® plate welded with Alloy 625 filler .

Welded Condition

The strength of 0.375 inch (9.5 mm) AL-6XN plate GMA welded with an Alloy 625 filler metal is equivalent to annealed base metal. Elongation is, however, lower. Ductility can be restored by a cold working (CW) and annealing operation. The welded plate samples consistently ruptured in the Alloy 625 weld metal, not in the base metal.

The bend test is a common means of demonstrating the ductility of a welded piece. Figure 25 shows test specimens of 0.375 inch (9.5 mm) thick plate that had been GTA welded with Alloy 625 filler. Both the face and root sides of the welded specimens were bent around a mandrel radius twice the plate thickness without cracking.



HEAT TREATMENT

Open-Air Annealing

Catastrophic Oxidation

Bright Annealing

Heat Treatment

Open-Air Annealing

AL-6XN products are shipped from the mill in the fully annealed condition. Flat rolled products are annealed at temperatures above 2025 °F (1110 °C) and are then rapidly cooled to produce a fully austenitic microstructure. Since the cold formability of AL-6XN alloy is excellent, subsequent heat treatment is generally not required to maintain ductility and toughness. Hot-formed products generally must be heat treated above 2025 °F (1110 °C) followed by a rapid cool to dissolve any secondary phases that may have precipitated during the process. If the cooling after heat treatment is too slow, the corrosion resistance of the AL-6XN alloy will be markedly decreased. Furnace cooling of AL-6XN alloy should be avoided.

CAUTION: To avoid the risk of incipient melting, AL-6XN alloy should never be heated above 2350 °F (1290 °C).

Note that many furnaces that are used to heat treat stainless steels are not capable of operating above 1900°F (1040°C), which is 125°F (70°C) below the minimum suggested annealing temperature for AL-6XN alloy. While laboratory studies³¹ have demonstrated that second phases are not precipitated during heat treatments at 1950°F (1065°C) or above, and that this second phase precipitation is slow at temperatures above 1800°F (980°C), final heat treatment of AL-6XN alloy at temperatures below 2025°F (1110°C) is not permitted for material to be used in ASME pressure vessel construction.

CAUTION: Do not anneal below 2025°F (1110°C).

The period of time that the AL-6XN alloy must be exposed at a given temperature to be effectively annealed depends on several factors including the size of the workpiece and the annealing temperature. The time of exposure must be at least long enough to insure that the desired temperature is achieved everywhere through the thickness of the workpiece. Extended periods of thermal exposure are not beneficial.

Heat treatment in static air at temperatures above 1885°F (1030°C) for extended periods may result in a heavy oxide that will be difficult to remove.

CAUTION: All oxides must be completely removed before the alloy is put into service. See page 39: Descaling, Pickling and Cleaning for details.

Since the annealing temperature for AL-6XN alloy is above the melting temperature of copper, copper contamination cracking during annealing is possible. To prevent this, contact of material to be annealed with copper or high-copper alloy clamps, tooling, braze alloy, etc., should be avoided.

Catastrophic Oxidation

Like other alloys which contain substantial amounts of molybdenum, AL-6XN alloy is susceptible to catastrophic oxidation under certain conditions. At high temperatures, molybdenum trioxide, which is one of the products of oxidation of AL-6XN alloy, is usually evaporated from the metal surface. When volatilization is inhibited and liquid molybdenum trioxide remains in contact with the metal surface, deep pitting or rapid loss of metal over the entire exposed surface can occur. Such catastrophic oxidation can be prevented by bright annealing or by avoiding stagnant air conditions during open-air annealing. The following precautions are recommended when open air annealing:

- Avoid excessively tight furnaces, furnace loads which are tightly packed, or other conditions which inhibit the evaporation of the molybdenum trioxide.
- Avoid re-annealing of material which is heavily scaled.
- Avoid prolonged anneals, especially in the upper end of the annealing temperature range.

Bright Annealing

Material to be bright annealed must be clean and free of grease, oil or other contaminants (especially sulfur bearing lubricants). Bright annealing should be performed in hydrogen, vacuum, cracked ammonia, or in mixtures of hydrogen and nitrogen or inert gas which have dew points of -40°F (-40°C) or less. Material to be bright annealed should be loaded so as to avoid contact between adjacent pieces; otherwise, pieces may be bonded together during annealing. This is most likely to occur when stacked pieces are annealed at high temperature in gas with an extremely low dewpoint.

As with open-air annealing, some means of forced cooling must be provided to prevent the precipitation

of deleterious second phases after exposure at high temperatures. Cooling through the 1200 to 1900°F (650 to 1040°C) temperature range at a rate similar to that provided by air cooling is normally adequate. For a different heat-treating process, representative test pieces of AL-6XN alloy should be examined to demonstrate that the anneal and subsequent cooling produce a product having acceptable microstructure and properties.

Bright annealing, when properly performed, precludes the formation of scale and chrome-depleted areas on the surface, and therefore pickling is not required. Catastrophic oxidation will not occur during bright annealing. Bright annealing will not always heal pre-existing surface Cr-depletion, so if prior annealing treatments have been performed, it is vital to ensure that the material to be bright annealed is free from scale or pre-existing Cr-depletion. Excessively hot and long vacuum annealing may evaporate Cr from surface, especially if CrO_3 can form. Poor atmospheric control in vacuum annealing may allow either oxidation or carburization. Cooling rates following vacuum annealing are often very low, even when "gas quenching" practices are used. These cooling rates may not be adequate to prevent sigma precipitation in AL-6XN alloy.

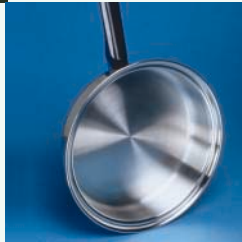

FORMING

Hot Forming

Warm Forming

Cold Forming

Tube Forming

Machinability

Cutting

Forming

Hot Forming

Hot-forming operations on AL-6XN alloy, including hot rolling, are generally performed in the temperature range of 1830-2300°F (1000-1260°C). Hot workability is actually reduced at higher temperatures and secondary phase precipitation can occur at lower temperatures. Secondary phases can be dissolved by subsequent heat treatment above 2025°F (1110°C) followed by rapid cooling. If the cooling rate is too slow, the alloy will be less resistant to corrosion.

Regardless of the thermal treatment, a heavy, tenacious surface scale will form when the alloy is heat treated in air at temperatures above 1885°F (1030°C). The formation of the oxide and the associated chromium depletion of the base metal can have a detrimental effect on corrosion resistance. Such scales and depleted surfaces must be removed. See page 39: Descaling, Pickling and Cleaning.

Warm Forming

Dishing and flanging operations are eased by preheating at or below 600°F (315°C). This may facilitate the deformation involved in forming pieces such as the vessel head shown in Figure 26. No significant reduction in strength or improvement in ductility occurs at temperatures in the range 600 to 1000°F (315 to 540°C). In all cases, warm-forming operations should be kept under 1000°F (540°C) to avoid precipitation of deleterious phases.

Cold Forming

AL-6XN alloy is very strong yet it can be easily cold formed much like other austenitic stainless steels. Operations such as bending, drawing and pressing can be readily performed even when the alloy is cold. For example, the pressing of complex plate-type heat exchanger panels is performed without difficulty (Figure 27). The high strength of the alloy means that additional pressure will be required for hold-down and forming relative to that for other 300 series stainless steels. Plate can normally be press-brake bent over a radius equal to the plate thickness. As with other austenitic stainless and nickel alloys, bending AL-6XN al-

loy over a sharp male die may cause the material to rupture in a ductile manner. Preheating prior to deformation is suggested when the high strength of AL-6XN alloy may exceed the capabilities of the forming press. Heat treatment after cold working is usually not required. The austenitic structure of the alloy is very stable and does not transform to martensite even under extensive forming.

Tube Forming

AL-6XN tubes can be bent to a minimum bend radius of two times the tube outside diameter (O. D.). With proper technique, AL-6XN alloy tubes (like other austenitic alloys) can be bent to tighter radii — down to 1.0 times the O.D. Heat treatment after tube bending should be limited to either a partial stress relief for short times below 1000°F (540°C), or a full anneal above 2025°F (1110°C) followed by fast cooling. Intermediate temperature heat treatments can degrade the corrosion resistance of AL-6XN alloy.

AL-6XN tubes may be roller expanded to the full thickness of the tube sheet. No provision need be made for staying back from the inside face of the tube sheet. Suggested tube expansion for 3/4 to 1 inch (19 to 25 mm) O.D. 22 gauge (–0.028 inches or 0.71 mm thick) AL-6XN tubes is 0.0025 to 0.0035 inches (0.06 to 0.09 mm) beyond metal-to-metal contact. Further expansion may distort the tube sheet ligaments. Once a torque setting has been established to give optimum results, it is suggested that rolling should be checked by measuring every fiftieth tube with a tube I.D. gage. Check this measurement with the initial calculation for final tube inner diameter (I.D.) as in the following formula:

FD = HD - (2 x W) + [7 to 10% of tube wall thickness] where:

FD = Final I.D. of tube after expansion
 HD = Hole diameter
 W = Wall thickness

Thin gage AL-6XN tubes should be expanded using a 5-roller expander. A 5-roller expander is suggested for thin wall condenser tubing because it tends to be more forgiving when operator skills vary. The 5-roller expander compensates for some misalignment of the expander with respect to the tube sheet bore. It is essential that the tool be designed with no space between the collar and the cage where the tube can be

pinched creating a work-hardened burr that may split when the tube end is flared. AL-6XN tube can also be expanded using hydraulic or explosive techniques.



FIGURE 26: A warm formed vessel head of AL-6XN® plate.
 (Courtesy Gaston County Fabricators)



FIGURE 27: AL-6XN® sheet cold pressed into a heat exchanger shell for a high efficiency residential furnace.
 (Courtesy Coleman Corporation)



Machinability

Satisfactory machinability may be achieved by selecting the correct tools and machine set-ups. The relatively high hardness (typically 88 RB) and the tendency of the AL-6XN alloy to work harden (see Figure 20) must be taken into account when planning machining operations. Guidelines for machining are given in Table 21. The following suggestions may also be useful:

- Chips of austenitic stainless steel tend to be stringy and ductile so that the use of curlers or breakers is suggested for turning operations.
- Machine tools should not be used at more than 75% of rated capacity.
- Both tool and workpiece should be rigid with minimum overhang.
- Tools should be reground at regular intervals to keep them sharp.
- Feed rate should be high enough to ensure that the tool cutting edge is getting under the previous cut thus avoiding work-hardened zones.
- The tool should not ride on the work piece as this will work harden the material and result in early tool dulling or breakage.

TABLE 21: Guidelines for machining AL-6XN[®] Alloy

Operation	Parameter	Value	Feed SFPM	Rate IPR
Turning	–	–	47-70	0.001
Cut-off	Tool Width	0.0625 - 0.5 inch	47-70	0.001
Forming	Tool Width	1.0 - 1.5 inch	47-70	0.001
Drilling	Diameter	0.25 inch	42-51	0.006
		0.75 inch	42-51	0.014
Reaming	Diameter	Under 0.5 inch	60	0.003
		Over .5 inch	60	0.008
Die Threading	Threads (Teeth) per Inch	3 - 7.5	4-8	–
		8-15	6-10	–
		Over 16	8-12	–
Tapping	–	–	20	–
Milling End Peripheral	Depth of Cut	0.050 inch	70	0.001 - 0.004
Broaching	Chip Load	0.003 inch / tooth	15	–

Operation	Thickness	Pitch, TPI	Speed	Feed Rate
Sawing	Under 0.75 inch	10	70	0.005
	0.75 - 2	6	70	0.005
	Over 2	4	70	0.005

- Heavy cuts will require slower speeds and the use of a lubricant is suggested.
- Lubricants such as sulfur-chlorinated petroleum oil are suggested. Lubricants may be thinned with paraffin oil for finish cuts at higher speeds. All traces of cutting fluid must be removed prior to welding, annealing, or using in corrosive service.

Cutting

AL-6XN plate may be wet or dry abrasive sawed, sheared, laser cut or plasma-arc cut. Shears rated for 3/8 inch (9.5 mm) mild steel are used to cut up to 1/4 inch (6.4 mm) thick plate. However, the AL-6XN alloy and other austenitic grades are quite ductile in the annealed condition but work harden more rapidly and require more power and time to cut by sawing than do plain carbon steels.

Like other stainless steels and nickel-chromium alloys, the properties of AL-6XN alloy can be degraded by carbon introduced during oxyacetylene or carbon-arc cutting.

CAUTION: AL-6XN alloy must not be cut by oxyacetylene or carbon-arc procedures.

Plasma-arc cutting is commonly used to cut shapes in AL-6XN plate through 2 inch (51 mm) thickness.

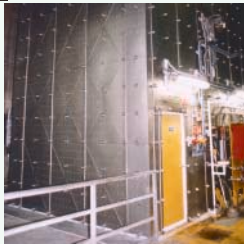

WELDING

Welding Specifications

Filler Metals

Typical Arc Welding Procedure

Non-Destructive Testing

Removal of Weld Defects

Corrosion of Welds

Chemical Segregation

Unmixed Zones

Crevices, Cracks & Fissures

Carbides

Sigma Phase

Heat Tints

Shielding Gas Composition

Welding

AL-6XN alloy is readily weldable using the normal methods for stainless steel.

Welding Specifications

Equipment that is intended for ASME Code approval is to be designed, fabricated, tested and stamped according to the latest edition and appendices of one or more of the following codes:

- ASME Boiler and Pressure Vessel Code, Section VIII, Division I including Paragraph UG-99
- TEMA-Code for Heat Exchangers
- American National Standards Institute (ANSI) B 31.

It is recommended that the ASME Boiler and Pressure Vessel Code be followed in all fabrications regardless of whether the equipment is to be ASME code stamped or not. Fabrication should be performed by workers fully qualified in the fabrication operations involved according to the ASME code.

The acceptable arc-welding processes for fabricating corrosion resistant piping and equipment from AL-6XN alloy²⁷ are:

- **Gas Tungsten Arc Welding** — Shielding and backing gas should be completely inert or contain 3-5% N₂ for enhanced corrosion resistance. Argon or argon-helium mixes are often used.
- **Gas Metal Arc Welding** — Use argon, argon-helium, or argon-helium with up to 2 1/2% CO₂ as the shielding gas. Avoid O₂ containing shielding gases
- **Shielded Metal Arc Welding** — Should only be used on thicknesses exceeding 0.125 inches (3.2 mm).
- **Flux Cored Arc Welding** — If available, a tubular 625 wire should be used with 75% argon - 25% CO₂ shielding gas.
- **Submerged Arc Welding** — Carbon and silicon pick-up from the flux must be minimized to avoid loss of corrosion resistance and ductility.
- **Autogenous Welding** (i.e., welding without a filler metal) — Chemical microsegregation in these welds causes regions to be more susceptible to localized corrosion.

Autogenous welding can be used with the following precautions:³⁵

- Use of 3 to 5 volume percent nitrogen in the shielding gas, and
- A post-weld anneal above 2150°F (1180°C) followed by rapid cooling and pickling if a protective atmosphere was not used during annealing.
- The duration of the anneal must be sufficient to re-homogenize the weld segregation.
- The G48-B crevice test can be used to assess the quality of autogenously welded and annealed AL-6XN alloy.

In many applications, a post-weld anneal and pickle may not be possible such as large vessel fabrication or field welding of piping systems. In these cases, the exposure conditions must be carefully reviewed to determine if autogenous welds are satisfactory. Autogenous AL-6XN welds are more resistant to corrosion than similar welds of Types 316L, 317L and 904L. Their corrosion resistance is approximately equivalent to that of alloy 904L base metal and is superior to that of Type 316L or Type 317L base metal.

CAUTION: Do not use Oxyacetylene Welding because carbon pick-up from the flame lowers corrosion resistance.

Like other austenitic stainless alloys, AL-6XN alloy is susceptible to copper contamination cracking⁴⁵. To prevent this, contact of the weld groove and adjacent surfaces with copper, high-copper alloy clamps, tooling, braze alloy, etc., should be avoided.

Various types of flux have been developed recently that substantially increase the penetration of gas tungsten arc welds made in stainless steels. The flux, which is applied to the surface of the weld joint in the form of a paste, may increase weld penetration up to 300% without a change in welding parameters. Advantages are decreased welding time and a lower overall heat input to the material. These fluxes, such as the commercially available FASTIG SS-7™, in conjunction with the proper filler metal have been shown to provide these advantages when welding AL-6XN alloy without affecting the overall corrosion resistance of the weldment.

Filler Metals

AL-6XN products have homogeneous compositions on delivery. However, when the alloy is melted in weld-

ing, elements such as chromium, nickel and particularly molybdenum are segregated in the weld. Such autogenous welds may be susceptible to preferential attack in severely corrosive environments. A filler metal composition must compensate for chemical segregation in the weld bead. Consequently, filler metals containing at least 9% Mo are recommended for welding AL-6XN alloy when joining it to other austenitic, ferritic and duplex stainless steels and most nickel-base alloys³³. The recommended weld filler metal (consumables) comply with the American Welding Society (AWS), American Society of Mechanical Engineers Specification (ASME) and Unified Number System (UNS) specifications cited in Table 18. Other nickel-base, high-molybdenum filler metals may also be acceptable if they meet the criteria described below. Consult with Allegheny Ludlum if there are questions about other acceptable filler metals. Fully basic or basic rutile types of consumable coatings are suggested.

AL-6XN alloy has been assigned to P Number 45 in Section IX of the ASME boiler and pressure vessel code. This group includes other Fe-Ni-Cr-Mo alloys such as alloys 20, 800, 825, 904L and G.

The choice of the best filler for AL-6XN alloy depends on the service environment and the fabrication situation. Historically, the filler metal most frequently used to weld AL-6XN alloy is Alloy 625, which contains about 9% molybdenum. This level of molybdenum enrichment provides little margin for dilution of the filler by the base metal. Recent studies⁴⁸⁻⁴⁹ have identified other filler metals, especially Alloy 22, as being superior. The desired pitting corrosion resistance of weldments of AL-6XN alloy can be achieved by selecting filler metals having Pitting Resistance Equivalent Number (PRE_N) values at least ten higher than the base metal regardless of the type of arc welding process. If these filler metals are used, the weldment will have pitting and crevice corrosion resistance about equal to that of the parent metal. In certain applications such as oxidizing acid chlorides, the chromium content of the filler metal is also important.

Since the melting temperature of the AL-6XN alloy [2410-2550°F (1320-1400°C)] is greater than that of the filler metals Alloy 625 [2350-2460°F (1290-1350°C)] and Alloy 276 [2415-2500°F (1320-1370°C)], care must be taken to ensure that the base metal has been properly melted into the filler metal.

When welding a dissimilar metal such as Type 304 stainless steel, low alloy steel or carbon steel to AL-6XN alloy, the AWS ERNiCrMo-3 consumables may be used.



Typical Arc Welding Procedure

Many potential problems such as weld porosity, lack of fusion, incomplete penetration, misalignment, excess weld metal, overlap, undercut and arc strikes, can be avoided by paying careful attention to fit-up, surface preparation, cleanliness and welding technique. Typical parameters for welding AL-6XN alloy are given in Table 23. Recommendations for an AL-6XN alloy gas-arc welding practice are offered below.

Surface Preparation — Contaminants such as shop dirt, grease, oil, crayon markings, lubricating and cutting fluids, adhesive tapes, sulfur compounds, marking inks, paints and liquids should be removed from the welding surface and adjacent areas for 2 inches (50 mm) on either side. Vapor degreasing or scrubbing with a solvent should be effective in removing all but paint. Alkaline cleaners are required to remove paint. Alkaline cleaners containing sodium sesquisilicate or sodium carbonate must also be removed by scrubbing with water. The difficulty of surface preparation can be reduced by avoiding damage and contamination in handling and storage.

Edge Preparation and Joint Alignment — A plate planer or similar machine tool is used to bevel the edges and create a true land. Hand grinding is tedious but can produce acceptable results. Joint design guidelines are given in Table 20. The GTAW process with 100% welding grade argon torch shielding gas is the preferred method for the root pass with all joint designs. External half pipe coils are an exception and may be welded by GMAW. In square butt welding thin material, the

However, stainless filler metals E309 Mo or E309L are preferred for economy and to ensure better fusion. The thermal expansion and conductivity of the dissimilar metals must be compatible to minimize the possibility of cracking in the weld and distorting the adjacent base metal.

TABLE 22: Consumables for welding AL-6XN[®] Alloy

Welding Process Designations			Filler Metal Alloy	Consumable			
				Specifications		Classifications	
AWS	Common	Form		AWS	ASME	AWS	UNS
GTAW	TIG	Bare Welding Rods & Wire	625	A5.14	SFA5.14	ERNiCrMo-3	N06625
			276	A5.14	SFA5.14	ERNiCrMo-4	N10276
			22	A5.14	SFA5.14	ERNiCrMo-10	N06022
GMAW	MIG	Bare Welding Rods & Wire	625	A5.14	SFA5.14	ERNiCrMo-3	N06625
			276	A5.14	SFA5.14	ERNiCrMo-4	N10276
			22	A5.14	SFA5.15	ERNiCrMo-10	N06022
SMAW	Stick or Covered Electrode	Coated Electrodes	112	A5.11	SFA5.11	ENiCrMo-3	W86112
			276	A5.11	SFA5.11	ENiCrMo-4	W80276
			22	A5.11	SFA.11	ERNiCrMo-10	W86022

GMAW and SMAW (3/32 inch [2.4 mm] diameter electrodes) processes may be used in addition to GTAW, provided that the material is no greater than 1/8 inch (3.2 mm) thick. Square butt joints must not be used to join AL-6XN alloy over 1/8 inch (3.2 mm) thick. The root pass in V-, U-, J-, T- and Opening-type joint designs are only to be made with the GTAW or GMAW processes but the remainder of the joint may be filled by either GTAW, GMAW or SMAW processes. Guidelines for joint designs based on material thickness are also given in Table 24.

Installation of Square Corner Grooved Backing Bar — The use of a square corner grooved backing bar made of copper is recommended to provide 100% argon backing gas coverage while the tack welds and the root pass are being made for all joint designs. Gas flow for back-up on the root pass should be 35-45 cubic ft/hr

(0.28 to 0.35 liter/second). The enclosed volume should be purged a minimum of seven times before welding begins. The shielding gas should precede arc initiation by several seconds and should remain on and be held over the weld pool for at least five seconds after the arc is extinguished. The turbulence of the gas column should be reduced by a gas diffuser screen (gas lens) on the GTAW torch. Argon should be fed in at the bottom and out at the top. The use of other shielding gas additions such as oxygen and carbon dioxide are not to be used for metallurgical reasons. The use of 3 to 5 volume % N₂ with the argon shield-gas is recommended for autogenous welding.

Preheating — Do not preheat AL-6XN alloy except when the material is below 50°F (10°C). In such a case, the joint is to be heated above 50°F (10°C) to prevent the condensation of moisture in the weld area.

TABLE 23: Typical welding parameters for MAW of AL-6XN ® Alloy

Welding Process	Preferred Transfer Mode	Shield Gas	Flow Rate Cu ft / hr.	Wire Dia. Inches (mm)	Electrode Amps	Volts	Polarity
GMAW	Short-Circuit Arc	100% Ar	25-45 0.045 (1.1)	0.035 (0.9) 110-140	90-120 20-22	19-21	positive
GMAW	Pulsed Arc 120 pulses / sec.	75% Ar+ 25% He	25-45	0.035 (0.9) 0.045 (1.1)	90-120 150-165	19-21 20-21	positive
GMAW	Spray Arc	100% Ar	35 45 55	0.035 (0.9) 0.045 (1.1) 0.062 (1.6)	180-220 200-260 250-320	28-34 28-34 30-34	positive
SMAW	Manual			0.094 (2.4) 0.125 (3.2) 0.156 (4.0)	40-70 60-95 90-135	24 25 26	positive

A constant voltage power source is recommended for all processes except GTAW, plasma-arc and SMAW, which should have a constant power source.

TABLE 24: Guidelines for AL-6XN ® Alloy welded joint design.

Joint Design	Welding Process	Thickness Inch (mm)		Gap Inch (mm)		Min. Land Inch (mm)	Joint Bevel	
		Max.	Min.	Max.	Min.		Angle	Min. Radius Inch (mm)
Square Butt	All	1/8 (3)	—	3/32 (2)	1/16 (1.6)	—	—	—
V	GTAW	1/2 (13)	3/16 (5)	3/32 (2)	1/16 (1.6)	1/32 (0.8)	60-75°	—
V	SMAW	1/2 (13)	3/16 (5)	1/8 (3)	1/16 (1.6)	1/32 (0.8)	60-75°	—
Double V	GTAW		1/2 (13)	3/32 (2)	1/16 (1.6)	1/32 (0.8)	60-75°	—
Double V	SMAW		1/2 (13)	1/8 (3)	1/16 (1.6)	1/32 (0.8)	60-75°	—
U	All		3/4 (19)	1/8 (3)	1/16 (1.6)	1/32 (0.8)	15°	3/8 (9)
Double U	All		3/4 (19)	1/8 (3)	1/16 (1.6)	1/32 (0.8)	15°	3/8 (9)
J	All		3/4 (19)	1/8 (3)	1/16 (1.6)	1/32 (0.8)	15°	3/8 (9)

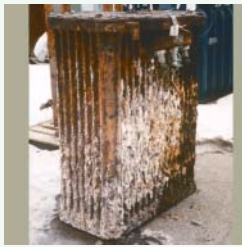

If an oxyacetylene torch is used for preheating, apply heat evenly to the base metal rather than on the prepared joint surface. In this way hot spots and carbon pick-up will be minimized.

Tack and Root Welding — Ignition of the electrode should always take place at a point within the joint itself. Possible striking scars alongside the joint must be removed by fine grinding followed by polishing. Use sufficient current to obtain a smooth arc and proper fusion of the weld metal to the base metal. The arc energy input used should not exceed 38,000 joules per inch (15,000 joules per centimeter). Do not place a tack weld at the starting point for the actual root pass weld.

Forming Weld Bead Stringers — Deposit a straight stringer with a distinct crown (convex surface) to minimize heat input. Weld beads that have a flat or concave surface are unacceptable. (Weld bead contour and shape are very important to minimizing fusion zone hot cracking.) If a slight weave is used, the width should not exceed two times the diameter of the electrode. There should be no pits, porosity, cracks, pinholes, slag inclusions, undercutting, overheating, or other weld defects present in the fabricated equipment. Complete penetration is required on the entire length of the welded joint. The preferred practice is to grind all starting and stopping points, including both ends of the root pass.

Heat Input — Welding heat input should be as low as feasible for the joint involved. Preferably, stay below 40 kilojoule per inch and definitely below 50 kJ/in.

Heat input in kJ/inch is calculated:

$$\frac{\text{Voltage} \times \text{Amperage} \times 6}{\text{Travel Speed (inch/minute)} \times 100}$$

The nickel alloy weld fillers used with AL-6XN alloy give a more viscous weld pool than conventional stainless fillers. There is a temptation to raise welding current to improve fluidity, but this increases risk of hot cracking.

Interpass Temperature and Cleaning — Allow the weld metal to cool to below 200°F (95°C) prior to the next weld pass. Auxiliary cooling methods may be used between weld passes to speed up the overall welding operation providing they do not introduce contaminants that will remain in the joint. The preferred way to maintain a low inter-pass temperature is to allow the assembly to cool naturally.

All slag must be removed from each stringer prior to the start of the next pass and after the final pass. All finished welds should be ground smooth but not necessarily flush unless otherwise specified.

Non-Destructive Testing

Non-destructive test methods such as radiographic, dye-penetrant, ultrasonic and hydrostatic can be used as specified. These methods can also be used for intermediate inspections during equipment fabrication as well as for the final acceptance test. Certain mandatory non-destructive test inspections are required for ASME code fabrications. Consult the ASME Boiler and Pressure Vessel Code for the requirements pertaining to a given fabrication. Fillet and butt-welded joints should be given non-destructive test inspections even though the fabrication may not be governed by Code requirements.

When hydrostatically testing tube-to-tube sheet joints, it is important to control the microbial activity of every water source used for construction, testing, operation, maintenance, lay-up and replacement. Heat exchangers are critical in this regard because such units provide a boundary between raw cooling water and other process fluids in a closed loop. For example,

stainless steel and copper alloy heat exchanger tubing has failed prior to start-up because of the water left in the heat exchanger after hydrostatic testing. Microbes in the test water were allowed to breed and grow, resulting in microbially influenced corrosion. See page 22: Corrosion Properties — Microbially Influenced Corrosion (MIC).

Removal of Weld Defects

All rejectable weld defects should be completely removed by grinding. The ground crater should be dye-penetrant inspected to insure that all objectionable defects have been removed. The area of the repair should be thoroughly cleaned prior to the weld repair. Do not attempt to heal cracks and wash out defects by remelting weld beads or by depositing additional weld beads over a defect.

It is extremely important to clean the weld and adjacent regions after fabrication. Refer to page 39: Descaling, Pickling and Cleaning— Postweld Cleaning.

Corrosion of Welds

Chemical Segregation

Microsegregation or coring normally occurs in austenitic weld metal dendrites. Localized regions within a weld can contain significantly less molybdenum than adjacent regions. Such molybdenum-depleted regions are much more susceptible to localized attack, even in moderately oxidizing solutions. This mode of attack is most likely to occur when the GTAW process involves:

- no filler metal (i.e., autogenous welds),
- filler metal that has the same composition as the base metal, or
- high heat input.

The use of a filler metal that is overmatched in molybdenum is recommended for welding AL-6XN alloy to compensate for chemical segregation effects.

Unmixed Zones

High heat input welding can leave narrow bands of base metal adjacent to the fusion line that has been melted but not mixed with the over-matched filler metal. Such an unmixed zone behaves like an autogenous weld in a corrosive environment. Controlling the heat input and avoiding undercutting (i.e., allowing the final filler metal pass to flow beyond the fusion line) will help to prevent this problem.

Crevice, Cracks & Fissures

Defects such as residual welding flux and microfissures create crevices that are particularly susceptible to corrosion in chloride-containing environments. Some flux formulations on coated stick electrodes produce slags that readily detach (rutile or titania base) while others are difficult to remove completely (basic-coated electrodes for out-of-position welding) even by grit-blasting. Small particles of slag that remain on the surface can act as initiation sites for crevice attack.

Microfissures or their larger counterparts, hot cracks, also provide easy initiation sites for crevice attack which will drastically reduce the corrosion resistance of a weldment. Microfissures are caused by thermal contraction stresses during weld solidification and are a problem that plagues austenitic stainless steel fabrications. Small-scale microfissures are often invisible to the naked eye, and their existence can readily explain the unexpectedly poor pitting performance of one of a group of weldments made with filler metals of apparently similar general composition. The microfissure provides a crevice which may corrode because stainless alloys are more susceptible to crevice corrosion than to pitting. Microfissure crevice corrosion is often mistakenly interpreted as self-initiated pitting.

Crevice-corrosion sites can also occur at the beginning or end of weld passes, between weld passes, or under weld spatter areas. Weld spatter is most troublesome when it is loose or poorly adherent. Corrosion associated with microfissures in welded AL-6XN alloy units is best minimized by the use of an over-matched filler metal as described in detail on page 33: Welding—Filler Metals.



Carbides

The best known weld-related corrosion problem in stainless steels is weld decay (sensitization) caused by carbide precipitation in the weld heat-affected zone. Sensitization occurs in a zone subject to a critical thermal cycle in which chromium-rich carbides precipitate and in which chromium diffusion is much slower than that of carbon. The carbides are precipitated on grain boundaries that are consequently flanked by a thin chromium-depleted layer. This sensitized microstructure is much less corrosion resistant, because the chromium-depleted layer and the precipitate can be subject to preferential attack. The very low carbon content of AL-6XN alloy, typically 0.02% C or less, helps to provide an alloy that is not susceptible to sensitization during welding.

Sigma Phase

In certain environments, weld regions containing networks of delta ferrite and sigma phase in Types 304 and 316 are preferentially attacked, but the free-corrosion potentials are generally lower (less oxidizing) than that required to initiate attack on more highly alloyed metals. The composition of AL-6XN alloy has been carefully formulated to avoid delta ferrite and sigma phase-related problems during hot rolling and welding. The nitrogen in the alloy is very effective in retarding the sigma phase precipitation reaction.

The sigma phase is generally more corrosion resistant than the surrounding austenite since it is enriched in chromium and molybdenum. Preferential attack of the alloy-depleted regions surrounding sigma can be a problem when a welded metal is being used close to the limit of corrosion resistance.

Heat Tints

The conditions created by arc welding of austenitic stainless alloys can produce a surface oxide scale or heat tint that is composed principally of iron and chromium. The regions near the surface of a heat-tinted stainless alloy can be significantly depleted in chromium. The chromium-depleted layer of base metal beneath the heat tint is significantly less resistant to localized corrosion than the base metal in certain environments, such as oxidizing acid chlorides⁴¹. Pits initiated in the chromium-depleted surface layer can propagate

through sound base metal. The corrosion of the heat-tint oxide can also activate the metal beneath it in a manner similar to free iron particles on a surface.

A heat-tint oxide on an austenitic stainless alloy exposed in air first becomes obvious at approximately 750°F (400°C). Differently colored oxides develop at higher temperatures. Dark blue heat-tint oxides are the most susceptible to localized corrosion. Surfaces shielded by inert gas during welding can also be susceptible to preferential corrosion even though a distinctly colored heat-tint oxide is not apparent.

Whether a weld heat tint should be removed prior to service depends on the given alloy and service environment. Preferential corrosion at heat tinted regions is most likely to occur when an alloy is used near the limit of its corrosion resistance. Certain environments do not affect heat-tinted regions and some alloys are more resistant than others when heat-tinted. For instance, AL-6XN alloy remains more corrosion resistant than Alloy 904L and Type 317L when heat-tinted under identical conditions.²⁸

A heat-tinted surface can be restored by grinding to remove the oxide and the chromium-depleted layer followed by acid cleaning to remove any residual oxide, chemically depleted base metal or other surface contaminants. A poorly cleaned surface can be just as susceptible to attack as the original heat-tinted surface. See page 39: Descaling, Pickling and Cleaning.

Shielding Gas Composition

The chromium in a stainless steel has a strong chemical affinity for oxygen and carbon. Weld pools formed by electric-arc processes must be shielded from the atmosphere to:

- prevent slag formation and oxidation
- maintain a stable arc
- reduce contamination of the molten metal.

Inert gas mixtures are commonly used in GTAW processes to create a barrier between the solidifying weld and the atmosphere. The composition of a shielding gas can be modified to improve the microstructure and properties of GTA welds in austenitic stainless steels. Adding 3 to 5 volume % N₂ to the torch and backing shield gases enhances the corrosion resistance of AL-6XN alloy in oxidizing acid chloride solutions (Figure 28). Nitrogen in the shield gas also compensates

for that volatilized during welding (i.e., the nitrogen content of weld metal increases with the partial pressure of nitrogen in the GTA weld shielding gas). Porosity and concavity are observed in austenitic stainless steel weld metals when more than 10 volume % N₂ is added to an argon shielding gas.

Despite the beneficial effects of adding nitrogen to the GTAW shield gas, autogenously welded AL-6XN alloy should be post-weld annealed and pickled for optimum corrosion resistance.

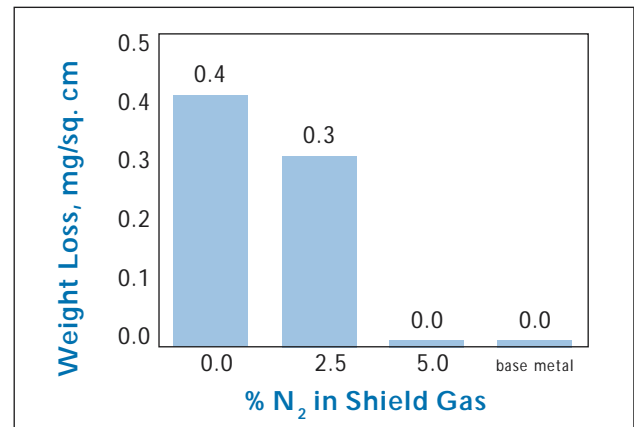
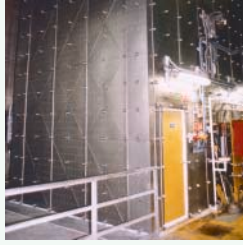

FIGURE 28: Effect of GTA weld shielding gas composition on the crevice corrosion resistance of autogenous welds in AL-6XN[®] alloy tested per ASTM G-48B at 35°F.



DESCALING, PICKLING & CLEANING

Descaling

Pickling

Passivation (Acid Cleaning)

Cleaning Embedded Iron & Scale

Post weld Cleaning

Descaling, Pickling and Cleaning

After operations such as heat treating, forging, or welding, it is necessary to remove tarnish or discoloration or oxide scale and the associated chromium-depleted layers. Descaling, pickling and cleaning can be labor intensive operations, but are crucial to optimizing the performance of the AL-6XN alloy in service. Removal is usually accomplished by a two-step process of descaling and pickling.

Descaling

AL-6XN alloy can be descaled by either mechanical or chemical cleaning methods. The more common mechanical methods include blasting, grinding, machining, and brushing. Blasting involves either steel shot blasting or grit blasting with steel, sand or alumina grits. Under certain circumstances, blasting with 75-100 μm soda-lime glass beads followed by polishing is effective. Grinding or machining have been successfully used to remove in one operation both scale and the chromium-depleted layer from AL-6XN alloy. Chemical methods of descaling are suggested for thin sections of AL-6XN alloy that may be distorted by the force of blasting.

CAUTION: Do not use carbon steel or low alloy stainless (e.g., Type 410) wire brushes or brushes that have been used on surfaces other than stainless steel to clean AL-6XN alloy. Iron from the wire brush will contaminate the AL-6XN alloy surface and may initiate pitting when exposed to an aggressive service environment. Wire brushing typically smears, rather than removes contamination and has been typically found to be ineffective in producing a fully-descaled surface.

Mechanical methods of descaling as well as machining to final shape, should be followed by either pickling or passivation treatments. The time required to pickle or passivate depends on several factors including the operating conditions and surface roughness. For instance, rough blasted surfaces are relatively slow to pickle or passivate because the microbubbles and foreign particles that can be retained on a rough surface reduce the wetting action of the acids.

Highly oxidizing molten caustic solutions are often used to chemically descale heavy surface oxides. Such caustic solutions are used to condition the scale for complete removal in a subsequent acid pickling operation. Electrolytic processes for scale conditioning can also be successfully used.

Pickling

Descaling alone is not sufficient to fully restore the corrosion resistance of AL-6XN alloy after annealing. The subscale chromium-depleted layer must also be removed. Examination of commercially annealed material has demonstrated the existence of a chromium-depleted layer approximately 12µm (0.0005 inch) thick at the metal surface just below the scale. This chromium-depleted layer is typically removed by pickling in nitric plus hydrofluoric acids at 130-140°F (54-60°C). The high corrosion resistance of AL-6XN alloy makes it difficult to pickle. Laboratory corrosion tests in 10% nitric plus 3% hydrofluoric acids (ASTM A-262-86 Practice D solution, based upon typical pickling solutions for stainless alloys) at 70°C (158°F) for four hours yielded the corrosion rates shown²⁹:

These results indicate that AL-6XN alloy must be pickled much more aggressively than standard stainless steel alloys; conversely, they also demonstrate that over pickling of AL-6XN alloy is not a serious possibility. The rate of pickling can be increased by adjusting the temperature or composition of the pickling acids. Increasing the temperature, increasing hydrofluoric acid concentration and decreasing nitric acid concentration promote more rapid pickling. The utility of increased temperature in accelerating nitric/hydrofluoric acid pickling is limited, however, by the volatilization of the nitric and hydrofluoric acids at elevated temperatures. For AL-6XN alloy, the speed of pickling can be increased by using a bath of 4:4 nitric/hydrofluoric acid solutions rather than the 10:2 typically used for ordinary stainless steels. Excessive concentrations of metal ions (iron, nickel, chromium, etc.) in the pickling acid may inhibit pickling. These nitric/hydrofluoric acid solutions used for pickling also suffice to remove free iron, etc., from the surface if any was embedded during the descaling process.

Passivation (Acid Cleaning)

Passivation is a frequently misunderstood term that is commonly used to describe a cleaning treatment involving a weak oxidizing acid such as warm 10 to 20% nitric acid. Such a treatment can promote the reformation of the passive film but the principal benefit of such a treatment is that it will remove contaminants. The acid cleaning (passivation) treatment will not corrode the AL-6XN alloy and is effectively used after machining, shipping or handling.

Cleaning Embedded Iron and Scale

Small particles of iron and scale may be firmly embedded in a stainless surface during fabrication and cleaning operations. Such embedded particles may not be removed by the cleaning methods normally used for dissolving grease or cutting compounds. Under certain conditions, the corrosion of such free iron particles may initiate localized attack of the stainless alloy. For this reason it is necessary to test for and to remove any free iron present on the surface. See Appendix B.

If embedded iron or scale is detected, it can be removed by applying either:

- 20% nitric acid or a commercial stainless cleaner
- Commercial stainless cleaner containing nitric and hydrofluoric acids suspended in a paste.

In all cases it is imperative that the cleaning agent be thoroughly removed by rinsing with water after the desired period of exposure.

TABLE 25: Pickling rates in 10% Nitric + 3% Hydrofluoric Acids at 70°C.

Alloy	Corrosion Rate	
	Inches Per Month (mm/y)	
Type 316L	0.21	(0.44)
AL-6XN®	0.01	(0.02)
Alloy 276	0.03	(0.06)

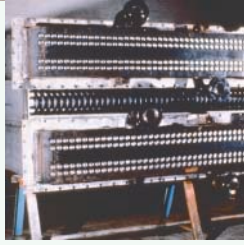

Postweld Cleaning

The high levels of corrosion resistance for the AL-6XN alloy are based on the performance of clean surfaces that are free of fabrication defects. Quite often weldments are put in service with surface conditions and defects due to fabrication that can initiate or accelerate the corrosion of otherwise sound metal. Table 26 describes and offers some guidance in correcting some of these conditions. The practical solution to these problems is to inspect fabricated surfaces and correct defects as a final step in the fabrication process.

TABLE 26: Remedial measures for fabrication defects and surface conditions.

Condition	Suggestions for Remedy
<p>Organic Contamination Marking materials (e.g., paint, oil, marking ink, temperature-indicating markers) can lead to crevice corrosion.</p>	<p>Remove the marking materials with a suitable solvent. Chlorinated solvents should be avoided for surfaces that cannot be rinsed (e.g., closed systems, surfaces with crevices or voids).</p>
<p>Embedded Iron Iron or steel tools previously used on carbon or low alloy steel must not be used. "Rusting" of embedded contaminants can initiate pitting or crevice corrosion.</p>	<p>Use a nitric-hydrofluoric acid pickle or abrasive blasting with clean sand or glass beads. Steel shot and contaminated sand must not be used unless the blasted surface can be thoroughly cleaned with acids. Acid cleaning after blasting is recommended.</p>
<p>Deep Scratches, Weld Splatter, Arc Strikes, Weld Undercut and Rough Grinding Burrs. Damaged surfaces can collect and concentrate contaminants and corrosive agents that could initiate crevice or pitting corrosion.</p>	<p>Use new grinding wheels and sanding materials. Do not use equipment that has previously been used on lower alloy steel surfaces. The abrasive grit size should be sufficiently fine to prevent rough burrs.</p>
<p>Heat Tint Light oxidation or heat tint often occurs next to the weld beads or from welding on the opposite plate surface. Heat tint can initiate base-metal corrosion in aggressive environments if not removed</p>	<p>Remove the heat-tint oxide and chromium-depleted layer by blasting (with glass beads or clean sand), grinding, and/or wire brushing. Acid cleaning (e.g., nitric-hydrofluoric acid paste) and water rinse is also suggested to completely remove the chromium-depleted layer and any residual surface contamination.</p>

References

1. J. R. Kearns, "The Effect of Nitrogen on the Corrosion of Austenitic Stainless Steels Containing Molybdenum," *Journal of Materials for Energy Systems*, Vol. 7, No. 1, p. 17 (1985).
2. H. E. Deverell, C. R. Finn and G. E. Moller, "Corrosion Performance of 6 Percent Molybdenum Austenitic Alloys AL-6X® and AL-6XN®," NACE Corrosion 88 Conference, St. Louis, MO, National Association of Corrosion Engineers, Paper No. 313, 1988.
3. J. R. Kearns and H. E. Deverell, "The Use of Nitrogen to Improve the Corrosion Resistance of FeCrNiMo Alloys for the Chemical Process Industry," *Corrosion*, Vol. 26, No. 6, p. 18 (1987).
4. H. E. Deverell, R. J. Bullock and J. R. Maurer, "The Corrosion Resistance of N08367 Stainless Steel for the Pulp and Paper Industry," NACE Corrosion 89 Conference, New Orleans, LA, National Association of Corrosion Engineers, Paper No. 56, 1989.
5. I. A. Franson and M. J. Johnson, "A New Nitrogen-Modified SuperAustenitic Alloy for Seawater Applications," NACE Corrosion 89 Conference, New Orleans, LA, National Association of Corrosion Engineers, Paper No. 296, 1989.
6. J. R. Maurer, "Application of a Six Percent Molybdenum Stainless Alloy for Nuclear Applications," NACE Corrosion 89 Conference, New Orleans, LA, National Association of Corrosion Engineers, Paper No. 501, 1989.
7. I. A. Franson and J. R. Maurer, "Application of a New High Strength Fe-Ni-Cr-Mo-N Austenitic Tube Alloy for High Pressure Feedwater Heaters," *Proceedings of EPRI Feedwater Heater Technology Symposium*, Winston-Salem, NC, Electric Power Research Institute, 1988.
8. I. A. Franson and J. R. Maurer, "An Advanced Fe-Ni-Cr-Mo-N Austenitic Alloy for Utility Heat Exchanger Service," *Proceedings of Advances in Material Technology for Fossil Power Plants*, Chicago, IL, ASM International, Paper No. 8706-007, 1987.
9. J. R. Maurer, "Improving a Stainless Condenser Tube Alloy with a Small Addition of Nitrogen," *Joint ASME/IEEE Power Generation Conference*, Milwaukee, WI, American Society of Mechanical Engineers, Paper No. 85-JPGC-Power-38, 1985.
10. A. Garner, "Materials Selection for Bleached Pulp Washers," *Pulp & Paper Canada*, Vol. 82, No. 12, p. 1 (1981).
11. B. Wallén, "Stainless Steel and Titanium Corrosion in Pulp Bleaching Plants," *1977 International Symposium Pulp and Paper Industry Corrosion Problems*, Houston, TX, National Association of Corrosion Engineers, p. 43 (1977).
12. L. H. Laliberte, "Corrosion of Stainless Steels in Bleach Plants," *First International Seminar on Pulp and Paper Industry Corrosion Problems*, Houston, TX, National Association of Corrosion Engineers, p. 51 (1974).
13. J. B. Hill and A. H. Tuthill, "TAPPI Phase II Corrosion Test Program-Part II: Weld Metal and Heat-Affected Zone Corrosion in Bleach Plant Environments," *Fourth International Symposium on Corrosion in Pulp and Paper Industry*, Stockholm, Sweden, Swedish Corrosion Institute, p. 142 (1983).
14. R. Bandy, Y. C. Lu, R. C. Newman and C. R. Clayton, "Role of Nitrogen in Improving the Resistance to Localized Corrosion in Austenitic Stainless Steels," *Equilibrium Diagrams and Localized Corrosion*, New Orleans, LA, Electrochemical Society, p. 471 (1984).
15. M. A. Streicher, "Analysis of Crevice Corrosion Data from Two Sea Water Exposure Tests on Stainless Alloys," *Materials Performance*, Vol. 22, No. 5, p. 37 (1983).
16. A. Garner, "Crevice Corrosion of Stainless Steels in Sea Water: Correlation of Field Data with Laboratory Ferric Chloride Tests," *Corrosion*, Vol. 37, No. 3, p. 178 (1981).
17. J. R. Kearns, M. J. Johnson and J. F. Grubb, "Accelerated Corrosion in Dissimilar Metal Crevices," NACE Corrosion 86 Conference, Houston, TX, National Association of Corrosion Engineers, Paper No. 228, 1986.
18. G. A. Gehring and J. R. Maurer, "Galvanic Corrosion of Selected Tubesheet/Tube Couples Under Simulated Seawater Condenser Conditions," NACE Corrosion 81 Conference, Toronto, Canada, National Association of Corrosion Engineers, Paper No. 202, 1981.
19. G. A. Gehring and R. J. Kyle, "Galvanic Corrosion in Steam Surface Condensers Tubed with Either Stainless Steel or Titanium," NACE Corrosion 82 Conference, National Association of Corrosion Engineers, Paper No. 60, 1982.
20. R. Otterberg, "The Influence of Boron Additions on the Corrosion Behavior of Some Austenitic Stainless Steels," *Proceedings of the Ninth International Congress on Metallic Corrosion*, Toronto National Research Council, Canada, p. 134 (1984).
21. J. R. Kearns, M. J. Johnson and I. A. Franson, "The Corrosion of Stainless Steels and Nickel Alloys in Caustic Solutions," NACE Corrosion 84 Conference, New Orleans, LA, National Association of Corrosion Engineers, Paper No. 146, 1984.
22. H. R. Copson, "Effect of Composition on Stress Corrosion Cracking of Some Alloys Containing Nickel," *Physical Metallurgy of Stress Corrosion Fracture*, Interscience, New York, p. 247 (1959).
23. M. Ueda, H. Abo, T. Sunami, T. Muta and H. Yamamoto, "A New Austenitic Stainless Steel Having Resistance to Stress Corrosion Cracking," *Nippon Steel Technical Report*, Overseas No. 2, January, p. 66 (1973).
24. J. W. Costerson and G. G. Geesey, "The Microbial Ecology of Surface Colonization and of Consequent Corrosion,"

- Biologically Influenced Corrosion, Gaithersburg, MD, National Association of Corrosion Engineers, Paper No. 223, 1986.
25. M. A. Streicher, "Development of Pitting Resistant Fe-Cr-Ni-Mo Alloys," *Corrosion*, Vol. 30, No. 3, p. 77 (1974).
 26. F. L. LaQue, "Qualification of Stainless Steel for OTEC Heat Exchanger Tubes," Argonne National Laboratory/Ocean Thermal Energy Conversion, ANL/OTEC-001, January 1989.
 27. "AL-6XN® alloy FABRICATION," Bulletin 203, June, 2001
 28. J. R. Kearns, "Corrosion of Heat Tinted Austenitic Stainless Alloys," NACE Corrosion 85 Conference, Boston, MA, National Association of Corrosion Engineers, Paper No. 50, 1985.
 29. J. F. Grubb, "Pickling and Surface Chromium-Depletion of Corrosion-Resistant Alloys," Proceedings of International Conference on Stainless Steels, Chiba, Japan, June 10-13, 1991, Iron and Steel Institute of Japan.
 30. J. F. Grubb and J. R. Maurer, "Correlation of the Microstructure of a 6% Molybdenum Stainless Steel with Performance in a Highly Aggressive Test Medium," NACE Corrosion 95 Conference, Orlando, FL, NACE International, Paper No. 300, 1995.
 31. J. F. Grubb, "Elevated Temperature Stability of a 6% Mo Superaustenitic Stainless Steel," NACE Corrosion 96 Conference, Denver, CO, NACE International, Paper No. 426, 1996.
 32. J. McConnell, J. Hamer, and I. Franson, "Applications of 6% Mo Superaustenitic Alloy in Severe FGD System Environments," Seventh International Seminar: Solving Corrosion Problems in Air Pollution Control Equipment, Orlando, FL, NACE International, Paper No. 16, 1992.
 33. T. G. Gooch and A. C. Elbro, "Welding corrosion resistant high alloy austenitic stainless steel," International Conference on Corrosion in Natural and Industrial Environments: Problems and Solutions, Grado, Italy, NACE International, Paper No. 13, 1995.
 34. J. R. Maurer, "Long-Term Tests of Dissimilar Metal Crevice Corrosion in Filtered Seawater," *Materials Performance*, Vol. 33, No. 4, p. 51 (1994).
 35. J. F. Grubb, "Corrosion Resistance of Welds in AL-6XN® Alloy," Eighth Annual North American Welding Conference, Columbus, OH, 1992.
 36. J. R. Maurer and J. R. Kearns, "South Carolina power plant upgrades to face highly corrosive environment," *Nickel*, Vol. 8, No. 3, p. 7 (1993).
 37. J. S. Perrin, D. B. Patten and T. S. Lubnow, "Service Water System Corrosion Test Program for Salem Units 1 and 2," EPRI Service Water System Reliability Improvement Seminar, Charlotte, NC, 1995
 38. NiDI Case Study No. 15001, "Nuclear Service Water Piping," Nickel Development Institute, 1994.
 39. R. S. Tombaugh and J. R. Maurer, "Retubing and Bundle Replacement for Life Extension of Nuclear Service Water System Heat Exchangers," 1991 International Joint Power Generation Conference, ASME, San Diego, CA, 1991.
 40. R. M. Kain, "Seawater Testing to Assess the Crevice Corrosion Resistance of Stainless Steels and Related Alloys," 12th International Corrosion Congress, Houston, TX, NACE International, p. 1889, 1993.
 41. J. R. Kearns and G. E. Moller, "Reducing Heat Tint Effects on the Corrosion Resistance of Austenitic Stainless Alloys," *Materials Performance*, Vol. 33, No. 5, p. 57 (1994).
 42. C. W. Kovach, "A Review of Microbiological Corrosion in 'High Performance Stainless Steels'," 1995 International Joint Power Generation Conference, ASME, Minneapolis, MN, 1995.
 43. A. H. Tuthill and A. Garner, "Field Test Results for 6% Mo Stainless and Ni Base Alloy Pipes in the Chlorination Stage of a Pulp Mill Bleach Plant," NACE Corrosion 92 Conference, Nashville, TN, NACE International, Paper No. 319, 1992.
 44. P. O. Gartland, U. Steinsmo, J. M. Drugli, and P. Solheim, "Highly Alloyed Stainless Steels for Chlorinated Seawater Applications - A Summary of Test Results for Eleven Austenitic and Duplex Materials," NACE Corrosion 93 Conference, New Orleans, LA, NACE International, Paper No. 646, 1993.
 45. E. F. Nippes and D. J. Ball, "Copper-Contamination Cracking: Cracking Mechanisms and Crack Inhibitors," *Welding J, Res. Sup.* Vol. 61, No. 3, March 1982, 75s-81s.
 46. E. L. Lustenader and F. W. Staub, "Development Contribution to Compact Condenser Design," INCO Power Conference 1964, Wrightsville Beach, N.C.
 47. J. F. Grubb, J. D. Fritz, B. W. Parks, Jr. and R.E. Polinski, "A 6% Mo Stainless Steel for Flue Gas Desulfurization," *NACE Corrosion 2000 Conference*, Houston, Texas, NACE International, Paper 00583, 2000.
 48. K.-K. Baek, H.-J. Sung, C.-S. Im, I.-P. Hong, and D.-K. Kim, "Resistance of High-Alloyed Stainless Steels Welds for FGD Plants in Korea," NACE Corrosion'98, Paper No. 474, NACE International: Houston, TX 1998.
 49. S. W. Banovik, J. N. DuPont, and A. R. Marder, "Fusion Welding of Super Austenitic Stainless Steels" Proceedings from Joining of Advanced and Specialty Materials, 9-11 October 2000, ASM International, 2000.
 50. S.C. Dexter and J. P. LaFontaine, "Effect of Natural Marine Biofilms on Galvanic Corrosion Predicted Using Potentiodynamic Polarization Curves," NACE Corrosion 98 Conference, San Diego, CA, NACE International, Paper No. 288, 1998
 51. J. D. Fritz, B. W. Parks, J. F. Grubb, and C. P. Stinner, "The Use of Electrochemical Critical Pitting Temperature Measurements for Evaluating Stainless Steels," *Stainless Steel World Conference & Expo 2001*, 13-15 November 2001, KCI Publishing B.V. Zutphen, The Netherlands.

Appendices

Appendix A - Corrosion Testing AL-6XN[®] Alloy

It is important to verify that products are in optimum condition prior to exposure to actual service, particularly in aggressive service environments.

Many highly alloyed materials, such as AL-6XN alloy, are susceptible to second phase formation, chromium-depleted zones, and oxidation scale from heat treating or welding that may impair performance. One way to evaluate manufacturing quality, as well as alloy corrosion resistance, is to place samples of finished material in an aggressive laboratory aqueous test solution. The Multiple Crevice Assembly (MCA) test for 6% molybdenum alloys is suggested because it provides for the tightest crevices via prescribed torquing of the creviced areas and is more consistent than that obtained with rubber bands in ASTM G-48B. Testing of the flat surface only is provided by the Multiple Crevice Assembly which is most representative of actual service crevice exposures.

Multiple Crevice Assembly (MCA) Test

The test method described covers a procedure for the determination of the crevice corrosion resistance of AL-6XN alloy when exposed to oxidizing chloride environments at a controlled temperature.

Reference Documents

ASTM G-46-94, ASTM G-48-00, ASTM G-78-01.

Test Solution

Dissolve 100 g of reagent grade ferric chloride ($\text{FeCl}_3 \cdot 6 \text{H}_2\text{O}$) in 900 ml of distilled water. Filter solution through glass wool or filter paper to remove insoluble particles.

Test Specimens:

1. Test multiple specimens. It is preferable to test welded specimens. If welded specimens are used, the region tested should include base metal, weld metal, and the HAZ.
2. Test specimens in the as-received condition (except for degreasing and acid cleaning). Blasting and pickling should not be performed unless the overall capability of the material is being determined. When testing welds, however, it may be necessary to grind the weld flat in order to get a valid test.
3. Minimum size sample should be 1.5 inches (38.1 mm) square or 1 inch (25.4 mm) x 2 inches (50.8 mm). One 0.375 inch (9.5 mm) diameter hole will be drilled in each specimen using a coolant to avoid heating. The hole will be located to allow the grooved delrin washer to be positioned so that the crevices include the weld, the heat-affected zone and the base metal (Figure 26).
4. Deburr and sandpaper the specimen cut edges and hole. Use a 120 grit abrasive paper.
5. Clean the specimen surfaces by immersing in an alkaline degreasing bath at 180°F (82°C) for five minutes, rinse with water, scrub surfaces with magnesium oxide paste or equivalent, and rinse well with water.
6. Acid clean (passivate) the specimens in 20% nitric acid by volume at 130°F (55°C) for ten minutes, rinse well with water, dip in acetone or methyl alcohol, and air dry.
7. Weigh the prepared specimen.

Apparatus

Cylindrical serrated delrin washers (G-78, Figure 27), two for each test specimen, will be applied (Figure 28). In the case of tubular or flanged specimens, one serrated delrin washer will be positioned on the inside surface, and for insulation purposes, one smooth delrin washer on the outside surface of the specimens. When testing specimens cut from a pipe or other curved surfaces, the delrin serrated washer will be ground to conform to the contour of the inside surface.

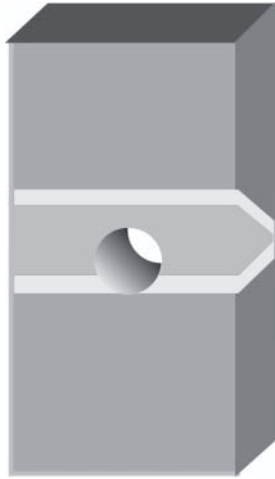

FIGURE 28: Welded crevice-corrosion test coupon.

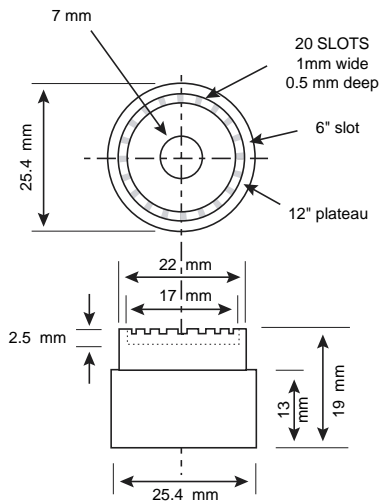

FIGURE 29: Schematic for crevice-corrosion test washer.

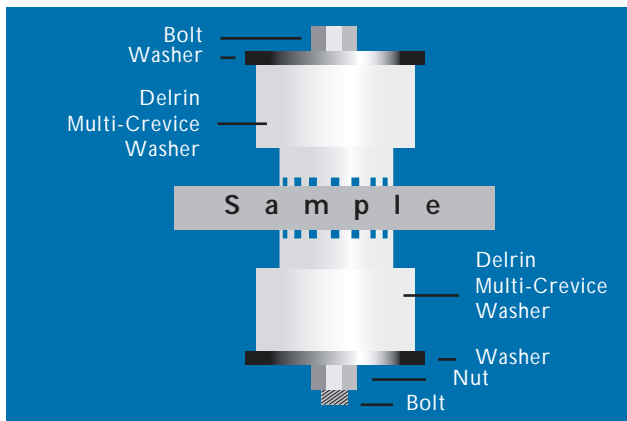

FIGURE 30: Crevice-corrosion test assembly.

Procedure

1. Pour 300 ml of ferric chloride solution into the test beaker, place a glass cover on top and place in a thermostatically controlled bath until it comes to an equilibrium temperature of $75 \pm 3^\circ\text{F}$ ($24 \pm 2^\circ\text{C}$).
2. Fasten two delrin washers to the specimen using a nut, bolt and two washers of UNS N10276 alloy or titanium. Torque to 55-60 in-lb (6.2-6.8Nm). Use a continuity measuring device to ensure no metal-to-metal contact. Use cloth or plastic gloves to avoid hand contact with metal surfaces during the operation.
3. After the test solution reaches the desired temperature, remove the watch glass cover and place one test specimen in each beaker. Replace the watch glass cover.
4. Test duration is 72 hours.
5. After the test has been completed, remove the test specimens, rinse with water and remove the delrin washers. Scrub the test specimens with a nylon brush under running water to remove corrosion products. Dip test specimens in alcohol and dry. Ultrasonic cleaning may be used when it is difficult to remove corrosion products.

Evaluation

1. Specimen surfaces shall be examined for evidence of crevice corrosion. Depth of crevice corrosion shall be measured using a dial depth gage.
2. Maximum depth of crevice attack allowed is 0.0015 inches (0.038 mm).
3. Maximum weight loss shall not exceed 0.0002 g/cm².

Report

Record the absence or presence of crevice attack. Measure and record maximum depth of crevice attack and weight loss (exceeding 0.0002 g/cm²), if any.

Equipment Calibration

All measuring equipment utilized in this procedure should be properly calibrated and/or checked as to a standard procedure.

Appendix B - Detection and Removal of Iron or Scale Embedded in a Surface

For large-scale testing, a solution of 1% chemically pure sodium chloride is suitable. After 12 to 24 hours in this dilute salt solution, iron particles are easily detected by the presence of rust spots. A salt spray may also be used, instead of immersing the entire workpiece in the solution.

The ferroxyl test for free iron, ASTM method A 380 section 7.3.4, works well for small-scale testing. The test is carried out by applying a potassium ferricyanide solution (Table 22) to the surface being tested.

From ASTM A 380-Cleaning and Descaling Stainless Steel:

1. Add nitric acid to distilled water and then add potassium ferricyanide.
2. The appearance of a blue stain within 15 seconds of application (by atomizer or swab) is evidence of surface iron contamination. Several minutes may be required for detection of oxide scale.
3. Remove the solution from the test surface as soon as possible with water or acetic acid and a fiber bristle brush.

Appendix C- Metallographic Examination of AL-6XN Alloy

Metallographic examination of AL-6XN alloy may be done to check for sigma phase precipitation or for general structural examination. For detection of sigma phase precipitation, a modified ASTM A 262 practice A (oxalic acid etch test) is typically used. The modified procedure differs in the following respects:

- The surface to be examined should be mechanically polished using standard metallographic procedures.
- The potential (rather than the current density) is controlled at 6 volts.
- The etching time is limited to 3 to 5 seconds.

Material which is essentially free of sigma phase, etc., will be practically unaffected by this procedure. Upon microscopic examination it will present an appearance similar to that of the 0.180 wt% N alloy shown in Figure 2. Material which contains sigma phase precipitates show etching of the grain boundaries similar to that shown by the 0.050 wt% N alloy of Figure 2.

General structural examination (for determination of grain size, etc.) is typically performed using standard metallographic polishing procedures followed by chemical etching. One etchant which has worked well with AL-6XN alloy is a mixed acids (modified glyceresia) reagent which is prepared and used as follows:

- Concentrated reagent grade nitric acid (10 ml), glacial acetic acid (10 ml), hydrochloric acid (15 ml) and glycerol (3 ml) are mixed together and allowed to stand for approximately 5 minutes.
- The freshly polished and dried specimen is swabbed continuously with the mixed acids reagent for 30 to 45 seconds.
- The etched specimen is then washed and dried before microscopic examination.
- It may be necessary to repolish and re-etch the specimen to get a clear microstructure
- Previously etched specimens must always be repolished before further etching is attempted.
- The mixed acids reagent can generate chlorine gas and must be used within a fume hood.

- The mixed acids reagent should be used within 45 minutes of preparation and excess reagent should be disposed of properly.

When properly done, this etching procedure will reveal the grain structure of AL-6XN alloy. It may also reveal the presence of sigma or other second phases, but the previously described modified oxalic etching procedure typically provides better definition in such cases.

Appendix D - Disclaimers

General

The data and information in this sourcebook are believed to be reliable. However, this sourcebook is not intended as a substitute for competent professional engineering assistance which is a requisite to any specific application. Allegheny Ludlum Corporation makes no expressed or implied warranty and assumes no legal responsibility for results to be obtained in any particular situation and shall not be liable for any direct, indirect, special, or consequential damages.

Referenced data are typical and should not be construed as maximum or minimum values for specification or for final design. Data on any particular piece of material may vary from those shown above.

This sourcebook is subject to revision without prior notice.

Safety in Testing and Fabrication

The tests, fabrication procedures and applications described may involve hazardous materials, operations and equipment. This sourcebook does not purport to address any of the safety problems associated with the testing, fabrication or use of AL-6XN alloy. Appropriate safety and health practices must be established to determine the applicability of regulatory limitations prior to testing, fabrication or use of AL-6XN alloy.

Hazardous Material Warning

AL-6XN alloy presents no health hazard unless it is welded, burned, ground, or cut. During such procedures, it is possible that hazardous fumes or dusts may be

generated. Any operation must be evaluated by a competent health professional to determine whether a hazard exists.

More complete information is available in the Material Safety Data Sheet for Category III-N: 330, 336, 337, 800, 904L.

AL-6XN® alloy products are covered by U. S. Patent No. 4,545,826.

Revision History

Edition 1: J. R. Kearns, 1990.
 Revision 1: J. R. Maurer, 1991.
 Edition 2: J. F. Grubb, 1995.
 Edition 3: J. F. Grubb & D. E. Deemer 2002

For Additional Information, Please Contact:

Allegheny Ludlum Corporation
 Six PPG Place
 Pittsburgh, PA 15222-5479
 412-394-2800
 412-394-3033 - Fax

Allegheny Ludlum Technical Center
 Brackenridge, PA 15014-1597
 USA
 724-226-5000
 724-226-5067 - Fax
 800-258-3586 - Tollfree (Sheet)
 800-289-7528 - Tollfree (Plate)

Allvac
 2020 Ashcraft Avenue
 P.O. Box 5030
 Monroe, NC 28111-5030
 USA
 704-289-4511
 704-289-4018 - Fax
 800-537-5551 - Tollfree

Trademarks

The Starburst Logo, AL-6XN, AL 29-4C and E-Brite are registered trademarks and AL-6XN PLUS is a trademark of ATI Properties, Inc.

Index

- Acid Cleaning, 47
- Alkaline Solutions, 21
- Annealing, Bright, 33
- Annealing, Maximum Temperature, 29
- Annealing, Minimum Temperature, 29
- Annealing, Open-Air, 29
- Annealing, Time at Temperature, 29
- Applications, 2, 10-13
- ASME Design Limits, 5
- ASME Maximum Allowable Design Stresses, 5, 9
- ASME Specifications, 8, 9, 30
- ASTM Specifications, 8,9
- Autogenous Welds, 39
- Biofouling, 23-25
- Bright Annealing, 33
- Carbides, 44
- Castings, 7
- Catastrophic Oxidation, 33
- Caustic Solutions, 21
- Chemical Composition, 3
- Chemical Segregation, Welds, 34, 43
- Chromium Depletion, 33-34, 44-48
- Cleaning, 47
- Cold Forming, 34
- Cold Work, Effect of, 27
- Corrosion, Erosion, 25
- Corrosion, General, 19-21
- Corrosion, Intergranular, 18
- Corrosion, Isocorrosion, 19-21
- Corrosion, Stress-Corrosion Cracking, 22-23
- Corrosion Testing, 51-53
- Cracking, Copper Contamination, 33, 39
- Crevice-Corrosion Resistance, 4-5, 14-16
- Crevices, Dissimilar Metals, 17
- Critical Crevice-Corrosion Temperature, 4, 16
- Critical Pitting, Temperature, 15
- Cryogenic Conditions, 28-29
- Cutting, 37
- Descaling, 46-47
- Dew Points, Bright Anneal, 33
- Disclaimers, 54
- Dissimilar Metal Crevices, 16
- Erosion Corrosion, 25
- Fatigue, 28-30
- Ferric Chloride Crevice-Corrosion Test, 4, 6, 15-18
51-53
- Filler Metals, 39-40
- Free Iron, 46-48, 53
- Galvanic Compatibility, 17-18
- General Corrosion, 19-21
- Heat Tint, 44-45
- Heat Treatment, 32-33
- Hot Forming, 34
- Intergranular Corrosion, 18
- Interpass Temperatures Welding, 42
- Isocorrosion, 19-21
- Low Carbon, 2, 3, 5, 44
- Machinability, 36-37
- Mechanical Properties, 28
- Metallography 53
- Metallurgical Stability 6-7
- Microbially Influenced Corrosion (MIC), 12, 23-25,
42-43
- Nitrogen, Effect of, 5-7, 14-15, 21, 45
- Non-Destructive Testing Methods, Welds, 42-43
- Passivation, 47
- pH, Effect of, 17
- Physical Properties, 26
- Pickling, 47
- Pitting, 14-15
- Pitting and Crevice-Corrosion Indices, 15
- Pitting Potentials, 14-15
- Pitting Resistance Equivalent (PREn), 3, 4, 14-15
- Product Forms, 2, 7-8
- References, 49
- Removal of Weld Defects, 43
- Seawater, 5, 11, 16
- Secondary Phases, 3, 5-7, 18, 32-34, 44, 53-54
- Shielding Gas Composition, 45
- Sigma Phase, 3, 5-7, 33, 44, 53-54
- Specifications ASME, ASTM, 8-9, 30
- Specifications, Welding, 38
- Strength, 4-5, 8-9, 28-30
- Strength at Elevated Temperatures, 29
- Stress-Corrosion Cracking (SCC), 22
- Tensile Strengths, 5, 19-20
- Toughness at Subzero Temperatures, 29
- Tube Forming, 35
- Typical Arc Welding Procedure, 40-42
- Unmixed Zones, Welds, 43
- Warm Forming, 34
- Welding, 38-45
- Welding Specifications, 38

Services

Full Service Processing • Technical Advice
 State-of-the-art Laboratories • Material Samples • Material Testing
 Technical Presentations • Material Failure Analysis • Nesting Programs

Electronic Services

Quote & Buy Online • Online Account Status • Electronic Test Reports and Certifications
 Online Technical Information • Electronic Invoicing • RA Mobile Connect
 Electronic Order Transfer • Online Industry Discussion Forum
 Shipping Notification • Advance Shipment Report

Product Form

Plate • Sheet • Bar • Pipe • Flanges & Fittings • Fasteners
 Welding Consumables • Billet • Expanded Metal

Processing

Waterjet • Laser • HI-DEF Plasma • Saw
 Shear • Gauer • Coil Leveling
 Threading

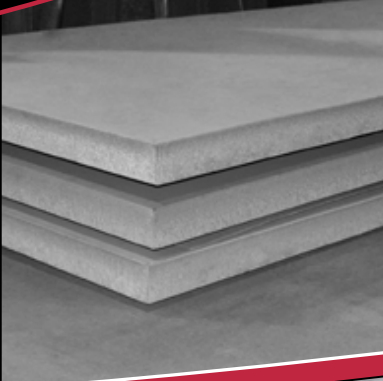

RA, RA330, RA333 and ZERON are registered trademarks of Rolled Alloys • 602 CA is a register trademark of Thyssen Krupp VDM • AL-6XN is a registered trademark of ATI Properties, Inc



People. Service. Expertise. Inventory.

253 MA and LDX 2101 are register trademarks of Outokumpu Stainless • 230 is a registered trademark of Haynes International • TRIBALOY and T-800 are registered trademarks of Deloro Stellite

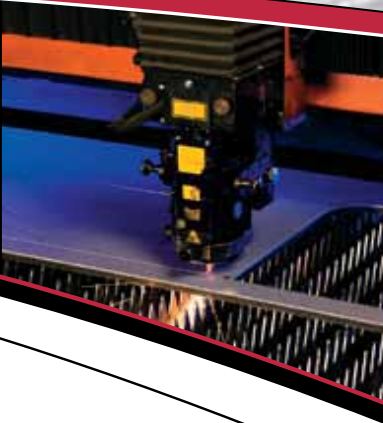

North America

California, USA: 1-800-321-0909 • Connecticut, USA: 1-800-521-0332
 Illinois, USA: 1-888-227-7862 • Michigan, USA: 1-800-521-0332
 Ohio, USA: 1-800-521-0332 • Oklahoma, USA: 1-866-664-4298
 Texas, USA: 1-800-728-1440 • Alberta, Canada: 1-866-469-9469
 Ontario, Canada: 1-800-521-0332 • Quebec, Canada: 1-877-450-4848
 E-mail: sales@rolledalloys.com

Global Locations

China • Czech Republic • England • France • Germany
 India • Italy • The Netherlands • Singapore • Spain